







DATA SHEET

AIRFLOW CONES FOR Ø 100 mm VANE ANEMOMETERS



Airflow cones are essential instruments for direct measurement of airflow in ventilation and air-conditioning systems. These instruments can be used with the Kimo Ø 100 mm vane anemometers from classes 110, 210 and 310 portable instruments.

-  **Supply and exhaust volume flow rate**
-  **Compact, easy to handle single-piece design**
-  **Designed for all major air vents**
-  **Integrated airflow straightener**
-  **For Ø 100 mm vane anemometers**
-  **Transport bag and Quick Start Guide**

Measurement principle

The Kimo Si-K25 and Si-K85 cones have a built-in honeycomb airflow straightener that reduces turbulence and enables more accurate airflow measurements. They are designed for accurate measurements of both straight and turbulent airflow on all major ventilation grilles and plate outlets, including multidirectional ones.



These cones feature a compact unibody design with no parts to assemble, making them easy to handle, especially in tight spaces.

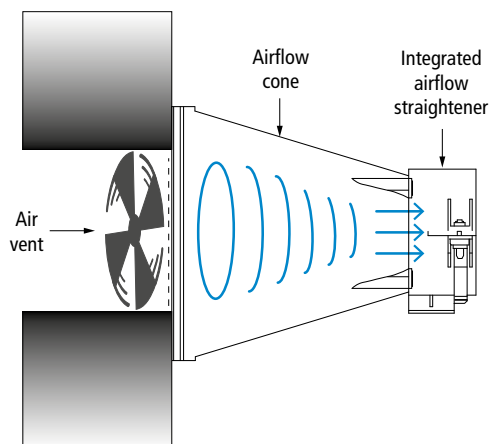

Cones for Ø 100 mm vane anemometers











Designation (Sales reference)	Si-K25 (28111)	Si-K85 (28112)
Flow	10 to 400 m ³ /h	10 to 400 m ³ /h
Internal dimensions	Ø 260 mm	350 x 350 mm
External dimensions	L 282 x W 282 x H 268 mm	L 372 x W 372 x H 327 mm
Weight	750 g	1,400 g
Material	PC-ABS	PC-ABS
Storage temperature	-20 to 60 °C	-20 to 60 °C

Integrated flow straightener

To ensure even more reliable measurements, this new-generation cone incorporates a honeycomb structure that reduces turbulence and produces a laminar flow suitable for vane anemometers on all types of vents.

Available kits

Designation (Sales reference)	 1 x Si-K25 Round Cone Ø 260 mm	 1 x Transport bag for Si-K25 Round Cone	 1 x Si-K85 Square Cone 350 x 350 mm	 1 x Transport bag for Si-K85 Square Cone	 1 x LV110 S Portable vane anemometer	 1 x Soft case for LV110 S	 Adjustment certificate for LV110 S	 Quick start guide
Si-K25 (28111)	✓	✓	-	-	-	-	-	✓
Si-K85 (28112)	-	-	✓	✓	-	-	-	✓
Si-CONESKIT1 (28113)	✓	✓	✓	✓	-	-	-	✓
Si-CONESKIT2 (28114)	✓	✓	✓	✓	✓	✓	✓	✓
Si-CONESKIT3 (28122)	✓	✓	-	-	✓	✓	✓	✓
Si-CONESKIT4 (28123)	-	-	✓	✓	✓	✓	✓	✓

How to use the air flow cones

1. Put the Ø 100 mm vane probe on the cone

- Open the lever and put the vane probe on the end of the cone.
- Put the vane probe at the bottom of the slot and close the lever.
- For a measure in **exhaust**, put the vane with the arrow turned towards the **inside** of the cone.
- For a measure in **supply**, put the vane with the arrow turned towards the **outside** of the cone.

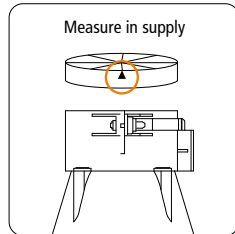
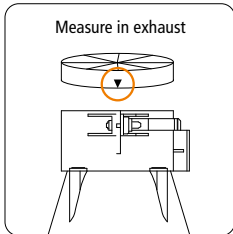

2. Put the cone on the air vent



Hold the cone by the cone handle.
Do not hold the assembly by the vane probe handle.

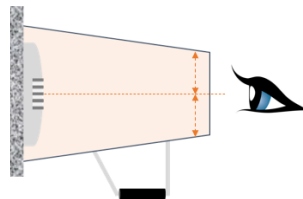









Do not pull on the probe handle when removing the Ø 100 mm vane probe from the cone.

- Position the cone against the wall (the support).
- Centre the cone for best results.
- Make sure the cone is tight against the wall.



Compatibility with our portable devices and probes

Designation (Sales reference)

LV 110 (24625)		Ø 100 mm remote vane probe thermo-anemometer with calibration certificate and soft transport case.	VT 210 L (24743)		VT 210 + SH100 Ø 100 mm remote vane probe (air velocity, airflow and temperature), transport case, calibration certificate, 1 charger, 1 USB cable, 2 mini-DIN cables for probe.
LV 110 S (24726)		Ø 100 mm remote vane probe thermo-anemometer with adjustment certificate and soft transport case.	MP 210 + SH100 (refer to specific data sheet)		MP 210 + SH100 Ø 100 mm remote vane probe (air velocity, airflow and temperature), transport case, calibration certificate (in option), 1 charger, 1 USB cable, 1 mini-DIN cable for probe.
LV 130 (24626)		Ø 100 mm integrated vane probe thermo-anemometer with calibration certificate and soft transport case.	AMI 310 + SH100 (refer to specific data sheet)		AMI 310 + SH100 Ø 100 mm remote vane probe (air velocity, airflow and temperature), transport case, calibration certificate, 1 charger, 1 USB cable, 2 mini-DIN cables for probe.
LV 130 S (24717)		Ø 100 mm integrated vane probe thermo-anemometer with adjustment certificate and soft transport case.	 Please refer to devices data sheets for more details on our probes and handheld instruments technical specifications.		