

PRODUCT DATA SHEET

Portable Ultrasonic Flowmeter

UFP-20



TOKYO
KEIKI

TOKYO KEIKI INC.

1. Outline

- 1) The time it takes to propagate ultrasonic pulses in a liquid varies according to flow velocity. This principle is utilized by ultrasonic flowmeters which provide signal output proportional to the flow rate.
The UFP-20 portable flowmeter can measure flow by simply positioning the transducers on the outside of pipes.
- 2) The UFP-20 flowmeter supersedes our model UFP-10 or UFP-1000 and offers a more compact design with additional functions such as pipe thickness measurement and liquid ultrasonic velocity measurement.



The UFP-20 is a high performance flowmeter which is simple to use. The UFP-20 incorporates an onboard DSP which carries out such functions as flow calculation and data processing in metric or inch units. The UFP-20 can be applied to pipe diameters from 13 ~ 5000 mm and is ideal for use with liquids such as clean water and wastewater. Three power sources (Ni-MH battery, AC, DC supply) allow flexibility to match conditions of the site and optional equipment such as optional transducers, extension cable and temperature input for heatmeter function enhance the range of applications.

2. Features

- 1) Multi-Flow Measurement Function

UFP-20 is able to easy configure for 2-Channel or 2-Path measurement.

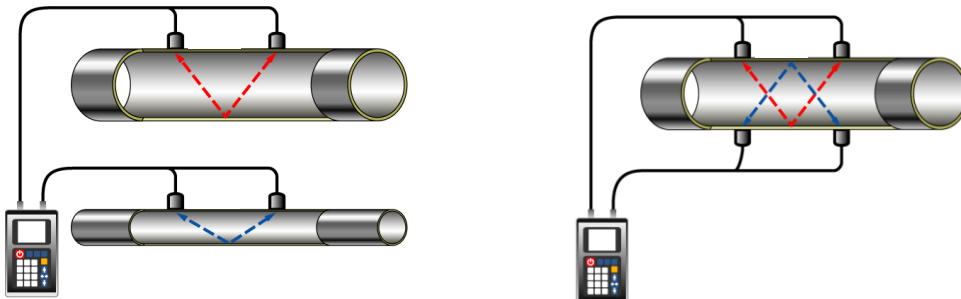

2) Energy Meter Function

UFP-20 can measure energy flow rate with Pt-100 RTD option.

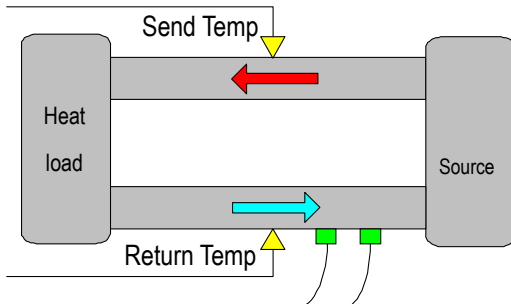

RTD direct connection!



3) Receiving-Echo Monitor Function

UFP-20 can confirm that receiving echo is “good” on main unit.

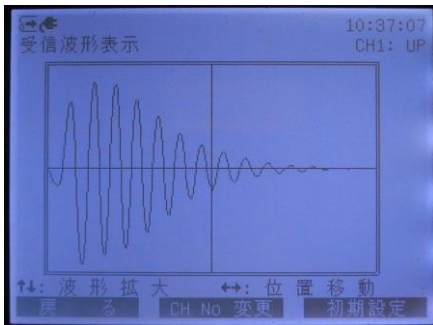

4) Weather-proof structure IP65

IP65 rating maintained even during measurement.



All Weather-Proof connectors

5) USB Memory Data Transfer

Logged data and site conditions can be stored into internal memory.

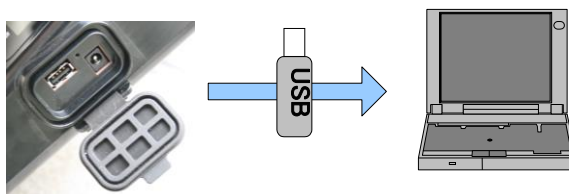

3. Configuration

Below model is a sample for typical flowmeter and heatmeter application with single and multi-channel configuration.

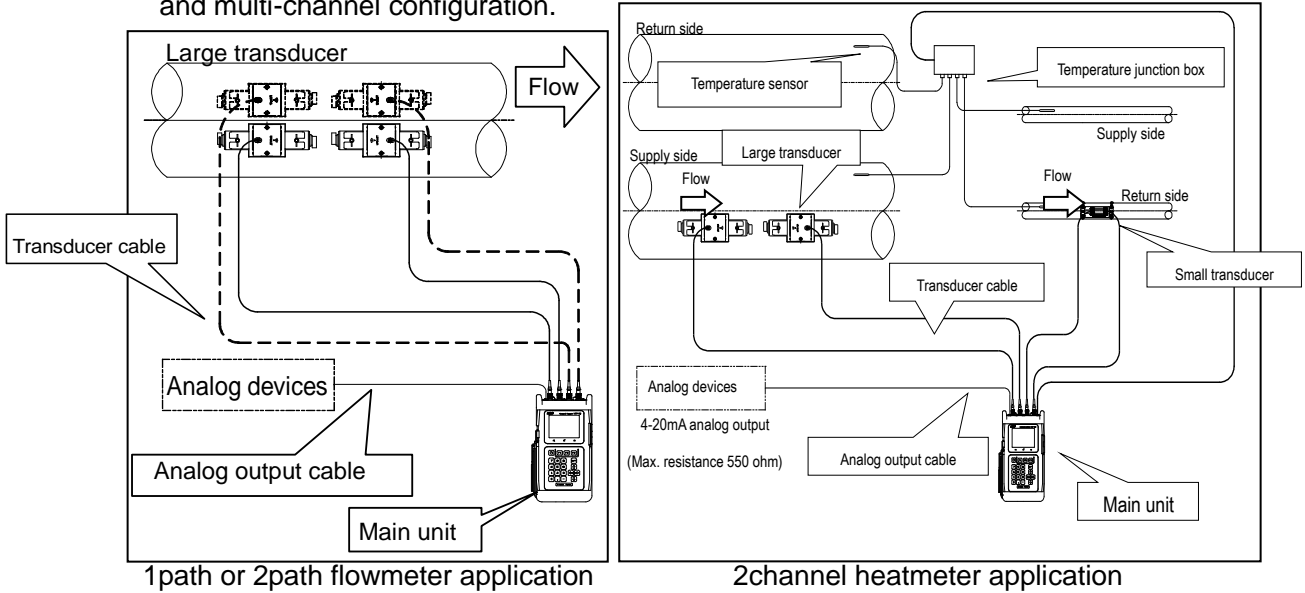

UFP-20 Portable Ultrasonic Flowmeter

Please select proper Sensor Kit form 1~7 in accordance with measuring pipe diameter range.

Main unit Kit (Primary components)







No.	Name	Q'ty	Details	Photo
1	Main unit	1pc	Ultrasonic flowmeter Main unit	
2	Battery	1pc	Ni-MH battery	
3	AC adaptor	1pc	AC adaptor for main unit	
4	Installation & Operation Manual	1pc	In English or Japanese	

Table 1.1-1 Main unit Kit (Primary components)





Sensor Kit 1 (for DN50^[*1]...65~200mm)

No.	Name	Q'ty	Details	Photo
S-1	Medium transducers	2pcs / 1pair	Ultrasonic transmitter-receiver sensors (to be used in combination with transducer cables)	
	Mounting fixture 1	1pc	Metal fixtures used to attach transducers onto pipe for DN50 ^[*1] ...65~200mm.	
	Transducer cable	1pair	Connection cable for transducer and main unit Temperature range : -20 to 65 degree C Length : 7 m	

[*1] In case of measurement of DN 50mm of Zinc-coated carbon steel pipe, "Medium transducer" and "Mounting fixture 1" are used.

Table 1.1-2 Sensor Kit 1 (for DN50...65~200mm)





Sensor Kit 2 (for DN20~500mm)

No.	Name	Q'ty	Details	Photo
S-2	Medium transducers	2pcs / 1pair	Ultrasonic transmitter-receiver sensors (to be used in combination with cables)	
	Mounting fixture 1	1pc	Metal fixtures used to attach transducers onto pipe for DN50 ^[*1] ...65~200mm.	
	Mounting fixture 2	1pc	Metal fixtures used to attach transducers onto pipe together with "Mounting fixture 1" for DN250~500mm.	
	Z-path method adaptor	1set	Metal fixtures used to attach transducers onto pipe by Z-path method together with "Mounting fixture 1" for DN20~40mm.	
	Transducer cable	1pair	Connection cable for transducer and main unit Temperature range : -20 to 65 degree C Length : 7 m	

[*1] In case of measurement of DN 50mm of Zinc-coated carbon steel pipe, "Medium transducer" and "Mounting fixture 1" are used.

Table 1.1-3 Sensor Kit 2 (for DN20~500mm)





Sensor Kit 3 (for DN50*...65~500mm)

No.	Name	Q'ty	Details	Photo
S-3	Medium transducers	2pcs / 1pair	Ultrasonic transmitter-receiver sensors (to be used in combination with cables)	
	Mounting fixture 1	1pc	Metal fixtures used to attach transducers onto pipe for DN50 ^[*1] ...65~200mm.	
	Mounting fixture 2	1pc	Metal fixtures used to attach transducers onto pipe together with "Mounting fixture 1" for DN250~500mm.	
	Transducer cable	1pair	Connection cable for transducer and main unit Temperature range : -20 to 65 degree C Length : 7 m	

[*1] In case of measurement of DN 50mm of Zinc-coated carbon steel pipe, "Medium transducer" and "Mounting fixture 1" are used.

Table 1.1-4 Sensor Kit 3 (for DN50...60~500mm)

Sensor Kit 4 (for DN20~200mm)

No.	Name	Q'ty	Details	Photo
S-4	Medium transducers	2pcs / 1pair	Ultrasonic transmitter-receiver sensors (to be used in combination with cables)	
	Mounting fixture 1	1pc	Metal fixtures used to attach transducers onto pipe for DN50 ^[*1] ...65~200mm.	
	Z-path method adaptor	1set	Metal fixtures used to attach transducers onto pipe by Z-path method together with "Mounting fixture 1" for DN20~40mm.	
	Transducer cable	1pair	Connection cable for transducer and main unit Temperature range : -20 to 65 degree C Length : 7 m	

[*1] In case of measurement of DN 50mm of Zinc-coated carbon steel pipe, "Medium transducer" and "Mounting fixture 1" are used.

Table 1.1-5 Sensor Kit 4 (for DN20~200mm)

Sensor Kit 5 (for DN13~50mm)



No.	Name	Q'ty	Details	Photo
S-5	Small transducers	2pcs / 1pair	Ultrasonic transmitter-receiver sensors (to be used in combination with cables)	
	Mounting fixture	1pc	Metal fixtures used to attach transducers onto pipe for DN13~50mm.	
	Transducer cable	1pc	Connection cable for transducer and main unit Temperature range : -20 to 65 degree C Length : 7 m	

Table 1.1-6 Sensor Kit 5 (for DN13~50mm)

Sensor Kit 6 (for DN300~1200mm)



No.	Name	Q'ty	Details	Photo
S-6	Large transducers	2pcs / 1pair	Ultrasonic transmitter-receiver sensors (to be used in combination with cables)	
	Mounting fixture (Belt type)	1set	Metal fixtures used to attach transducers onto pipe for DN300~1200mm.	
	Transducer cable	1pair	Connection cable for transducer and main unit Temperature range : -20 to 65 degree C Length : 7 m	

Table 1.1-7 Sensor Kit 6 (for DN300~1200mm)

Sensor Kit 7 (for DN300~5000mm)



No.	Name	Q'ty	Details	Photo
S-7	Large transducers	2pcs / 1pair	Ultrasonic transmitter-receiver sensors (to be used in combination with cables)	
	Mounting fixture (Magnet type)	1set	Metal fixtures used to attach transducers onto pipe for DN300~5000mm.	
	Transducer cable	1pair	Connection cable for transducer and main unit Temperature range : -20 to 65 degree C Length : 7 m	

Table 1.1-8 Sensor Kit 7 (for DN300~5000mm)

Carrying Cases (Recommendable Option)



No.	Name	Q'ty	Details	Photo
1	Carrying case	1pc	Carrying case for Main unit Kit and accessories 1set of Medium Transducer and 1set of Small Transducer can be contained inside together with mounting fixtures.	
2	Carrying case for Small or Medium transducer	1pc	Carrying case for small or medium Transducer for 2nd channel (Additional Sensor Kit 1~5)	
3	Carrying case for Large transducer	1pc	Carrying case for Large Transducer (Sensor Kit 6 or 7)	

Table 1.1-9 Carrying Cases (Recommendable Option)

Accessories (Optional)







No.	Name	Q'ty	Details	Photo
1	Protection cover	1pc	Protection cover for main unit	
2	Couplant	1pc	Acoustic couplant	
3	Analog output cable	1pc	Cable for analog output Length : 3 m	
4	Thickness gauge	1pc	Sensor thickness & sound speed measurement Length : 0.7 m	
5	Test piece	1pc	Calibration test piece for above sensor (No.4)	
6	High-Temp transducer cable	1pc	High temperature connection cable for transducer and main unit Temperature range : -20 to 120 degree C Length : 7 m	
7	Extension cables	1pc	50m of Extra connection cable between the transducers and main unit Temperature range : -20 to 65 degree C Length : 50 m	
8	Cigarette lighter cable	1pc	Cable for cigarette lighter port of automobile to supply power to flowmeter Length : 3 m	

Table 1.1-10 Accessories (Optional)

RTD Kit (Temperature Input Kit, Optional)

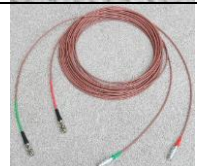

No.	Name	Q'ty	Details	Photo
1	Temperature junction box	1pc	Junction box for connection of 4pcs temperature sensor	
2	Temperature sensor	1pair	Temperature sensor Pt-100 (2pcs) Length : 5 m	
3	Metal tape for temperature sensor	1pc	Metal tape for temperature sensor attachment.	

Table 1.1-11 Temperature Options (Option)

4. Specifications

4-1. Overall Specifications

Measurement	Applicable Fluid	Homogeneous and sonically conductive fluids (water, waste water, industrial water sea water, pure water, oil, ethylene glycol-water solution etc)
	Range	Converted to flow velocity: -30 m/s to +30 m/s
	Method	Ultrasonic pulse transit time difference method
Pipe & Flow Condition	Diameter	DN13mm ~ DN5000mm (*1)
	Material	Materials which allow stable transit of ultrasonic waves such as steel, stainless steel, castings, ductile casting, PVC, PE, FRPM, GRP, HDPE etc. (Note: Applicable diameters may vary with material.)
	Turbidity	10000 mg/L or less
	Lining	None, tar epoxy, mortar, cement mortar etc.
	Flow Condition	Fully developed and rotationally symmetrical flow profile required.

(*1): Consult to vendor for DN7-DN10

Transducer	Applicable diameter	Applicable Temperature
Small Transducer	DN 13 ~ 50mm	-20~120 °C
Medium Transducer	DN 65 ~ 500mm (DN 20mm ~ 50mm) (*1)	-20~120 °C
Large Transducer	DN 300 ~ 5000mm	-20~80 °C
Measurement Accuracy of reading (*1)	Velocity \geq 1m/s	Velocity < 1m/s
DN 13mm (*2) ~ 90mm (DN 20mm ~ 50mm) (*3)	± 2.0 % (± 2.0 % ~ 5.0 %) (*3)	± 0.02 m/s (± 0.02 m/s ~ ± 0.05 m/s)
DN 100mm ~ 250mm	± 1.5 %	± 0.015 m/s
DN 300mm ~ 5000mm	± 1.0 %	± 0.01 m/s
Calibrated accuracy of reading (Repeatability)	Velocity \geq 1m/s	Velocity < 1m/s
DN 13mm ~ 90mm	± 1.0 %	± 0.01 m/s
DN 100mm ~ 250mm	± 0.75 %	± 0.0075 m/s
DN 300mm ~ 5000mm	± 0.5 %	± 0.005 m/s
Note	Water proof performance	Protection Degree IP65 (IEC 60529)
	Cable max. length	157m
	Temperature (Pt100)	IEC 60751 / JIS-A-Class (3-wires) (The total accuracy for energy measurement is synthesized from each flow rate and temperature accuracy.) (*4)

(*1): Calibrated accuracy defined on project specification as Option.

(*2): Site calibration required.

(*3): Medium transducer is recommended for measurement of DN20mm ~ 50mm which attenuates sonically like Zinc-coated carbon steel pipe.

(*4): The accuracy on the main unit for temperature detector is $\pm(0.2^{\circ}\text{C}+0.1\%)$ or less.

4-2. Main unit overview

Power Supply	DC 10 ~ 30 V (AC adaptor applicable on AC 90 ~ 264 V 47 ~ 63 Hz)
Internal Battery	8 hours as Max. / Rapid charging 4 hours
Operating Temperature	-10 ~ +50°C (for Main unit)
Storage Temperature	-10 ~ +50°C
Operating Humidity	20 ~ 90 %RH (non-condensation)
Main unit construction	Protection Degree IP65 (IEC 60529) / NEMA3
Housing Material	Polycarbonate-ABS synthetic resin
Dimension	135 (W) x 250 (L) x 68 (H)
Mass	Approx. 1.4kg (including battery)
European Compliance (CE marking)	EMC Directive 2014/30/EU Harmonised Standard / EN61326-1:2013 Separation into group / Group I Division into classes / Class A Location intended for use / In industrial locations RoHS Directive 2011/65/EU + (EU) /2015/863 Harmonised Standard / EN IEC 63000:2018 LVD Directive 2014/35/EU Harmonised Standard / EN61010-1:2010/A1:2019 [Condition] AC Adaptor is only used to recharge the battery. The length of sensor cable is 7m.

4-3. Display specifications

Display	Method	LCD (320 x 240 Dot Matrix) / high-intensity Backlight equipped		
	Content	<ul style="list-style-type: none"> Instantaneous flow rate, warnings, check mode and totalizing status. Instantaneous flow velocity value, warnings check mode and totalizing status. Forward/Backward flow totalized value, warnings, check mode and totalizing status. 		
	Digits	Flow rate	Max. 6 digits (including Sign section)	
		Flow velocity	Max. 6 digits Sign section ; 1 digit Integer section ; 2 digits Decimal fraction ; 3 digits	
		Flow Totalizing	Max. 8 digits	
Temp.		Max. 5 digits Sign section ; 1 digit Integer section ; 3 digits Decimal fraction ; 1 digit		
Unit	Flow rate units m ³ /s,m ³ /min,m ³ /h,m ³ /D,km ³ /s,km ³ /min,km ³ /h,km ³ /D,Mm ³ /D, L/s,L/min,L/h,L/D ft ³ /s,ft ³ /min,ft ³ /h,ft ³ /D,Mft ³ /D,bbbl/s,bbbl/min,bbbl/h,bbbl/D,Mbbbl/D gal/s,gal/min,gal/h,gal/D,Mgal/D,acf/s,acf/min,acf/h,acf/D,Macf/D kg/s,kg/min,kg/h,kg/D,t/s,t/min,t/h,t/D,kt/s,kt/min,kt/h,kt/D,Mt/D W,kW,MW,BTU/h,kBTU/h,MBTU/h Totalize units x1 m ³ ,x5 m ³ ,x10 m ³ ,x100 m ³ , x0.001 L,x0.01 L,x0.1 L,x1 L,x10 L,X100 L ft ³ ,kft ³ ,Mft ³ ,bbbl,kbbbl,Mbbbl,gal,kgal,Mgal,acf,kacf,Macf, x1 kg,x10 kg,x100 kg,x0.1 kg,x0.01 kg,x1 t,x10 t,X100 t J,kJ,MJ,BTU,kBTU,MBTU			
Updating cycle	Approx. 1sec			

4-4. Input / Output Specification

Logging Function	St'd/option	Standard
	Output	Approx. 165,000 points Date, Instantaneous flow rate, + Total, -Total, Flow velocity, Error code (Selectable) Internal logged data transferred through USB memory as CSV format
	Output format	CSV
Temperature Input	St'd/option	Option / Junction Box Required
	Input	4pcs of Pt100 (Max.) (For Energy measurement, they can be connected main unit through junction box.)
Analog Output	St'd/option	Standard
	Output	1 port; Instantaneous flow rate Energy, Mass (calculated by density setting), Calculated flow rate or energy (path1 + path2 or path1 - path2)
	Output format	4-20 mA Allowable load resistance 550 Ω Max.

4-5. Functions

Function	Installation Wizard	Installation Wizard for EASY interface
	Thickness meter	Thickness meter function included (Range; 1~100mm / Accuracy; +/-0.1mm or +/-1.5%R.D. which is larger)
	Sonic Velocity measurement	Sonic Velocity measurement function included (Range; 500~3000 m/s / Accuracy; +/-5 %)
	Multi-path measurement	2 path: - Flow meter main unit is equipped with connector for transducer cable as standard. - Transducer, fixture, extension cable for each path required. 2 channel: - Flow meter main unit is equipped with connector for transducer cable as standard. - Transducer, fixture, extension cable for each path required.
	Receiving echo-monitoring	Receiving echo-monitoring function included as standard
	Multi-Language available	Multi-Language available (English, French, German, Italian, Japanese, Portuguese, Russian, Spanish, Turkish)
	Metric / English	Metric / English (inch, gallon or barrel) units available
	Low flow cut	Cuts (zeros) flows when flow falls below prescribed instantaneous flow rate. Used in order to avoid output of flow values other than 0 when measurement value during still flow becomes disordered
	No Echo receiving warning	If measurement cannot be made when no echo is received continuously over the setting time (determined transition time), status is changed to - Display "R" on LCD. - Selected analog output type Selectable analog output transition status as follows. 0% (4mA), hold, 100% (20mA)
	Disturbance detection	Check whether processing values are measured properly or not and if determined to be disturbed conditions then measuring values are eliminated. Display "D" on the display
	Zero shift	Zero point can be independently compensated (shifted) for forward and backward flow rate.
	Span compensation	Slope of span line can be independently compensated for forward and backward flow rate.
	Self-diagnostics	Self-diagnostics runs at start-up.
	Moving Average time	Rapid flow rate changes would be smoother by this filter.
	Basic data display	Following internal data can be referenced. - Flow Unit and Flow Total Unit - Pipe Diameter, Thickness, Material and Material Sound Speed - Lining Thickness, Lining Material and Lining Material Sound Speed - Transducer Type, Sound-Path and Cable length - Fluid type, Fluid Sound Speed and Fluid Viscosity - Output Source, 4mA setting, 20mA setting and Alarm Output type - Zero Shift, Span Correction, Zero Cut and Volume Correction - Log Interval, Start & Stop time, Synchronizing Totalization select and Logged Items - Fluid sonic velocity

Function (Cont.)	Data Retention	Site conditions, Logged data and Date-Time are retained in memory with lithium battery even if power failure. Note: 1) Backup battery is non-recharge-able. 2) 5 year life at room temperature.
	Mass Indication	Mass flow rate is calculated by fixed density input.
	Temperature Compensation	Temperature input can be calibrated by Zero offset and Span correction in case of Heatmeter selected. Low cut function effects on the differential of both send and return side temperatures.

4-6. Accessories

Thickness /Acoustic velocity measuring Probe	St'd/option	Option
	Construction	Protection Degree IP65 (IEC 60529) / NEMA3
	Operating Temperature	-10 ~ +50°C
	Storage Temperature	-10 ~ +50°C
	Cable Length	0.7m
Temperature Detector (RTD)	St'd/option	Option
	Grade	JIS Class A (3 wires)
	Operating Temperature	-20 ~ +120°C
	Storage Temperature	-20 ~ +120°C
	Cable Length	5m
Temperature Junction box	St'd/option	Option
	Construction	Protection Degree IP20 (IEC 60529)
	Material	ABS resin
	Operating Temperature	-10 ~ +50°C
	Storage Temperature	-10 ~ +50°C
	Cable Length	2m
	Connection port	4 ports

5. Dimensions

5-1. Main Unit (UFP-20)

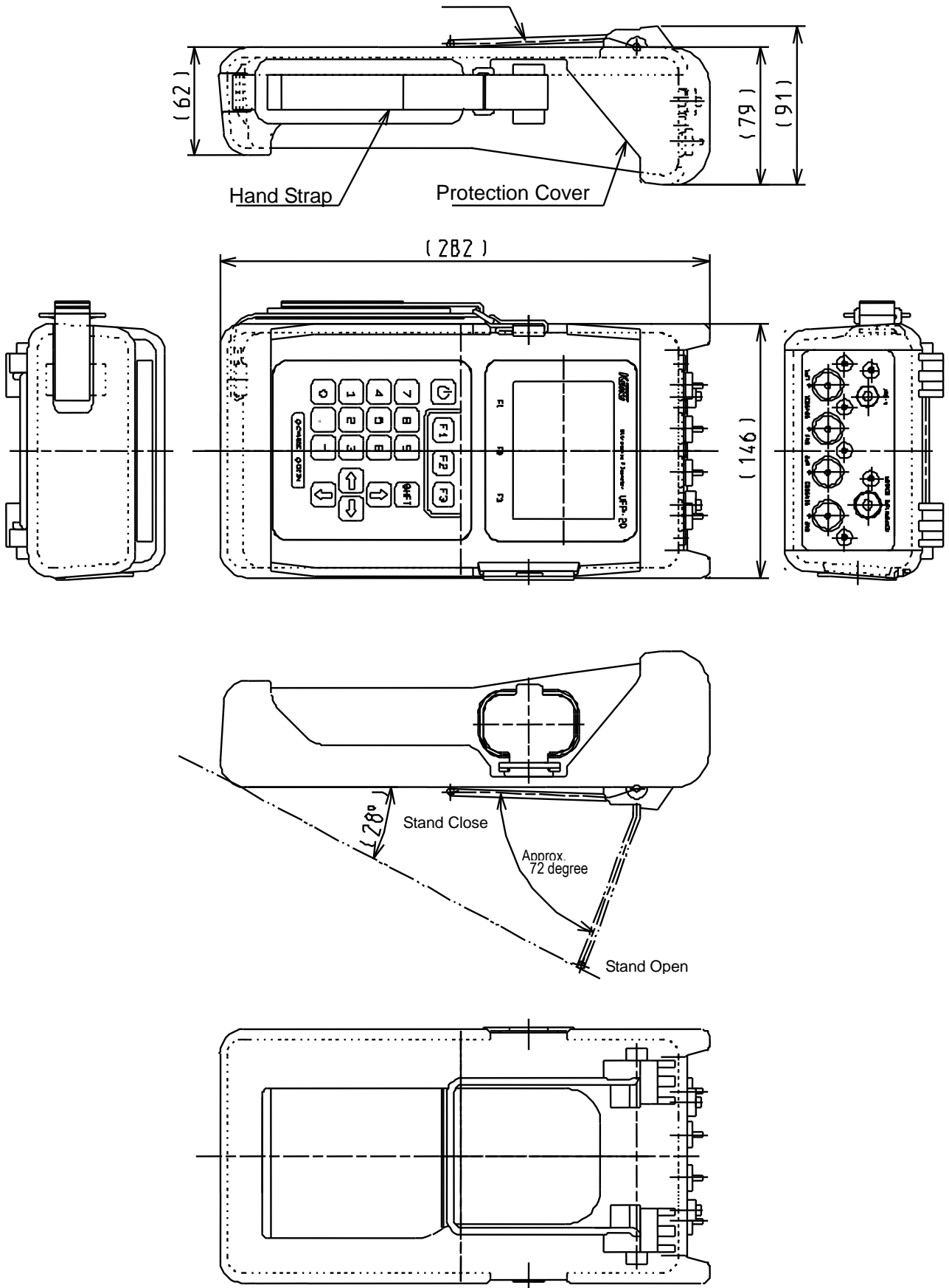

5-2. Small Transducer Kit

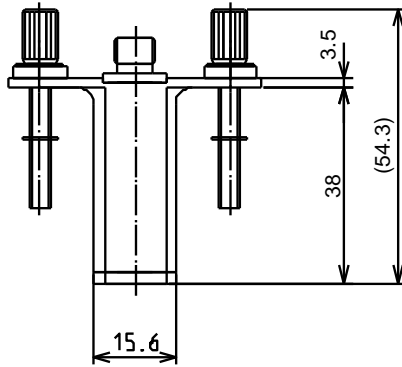
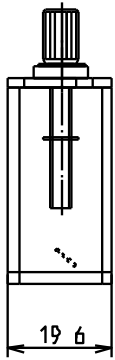
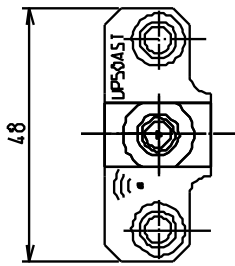

Small transducer

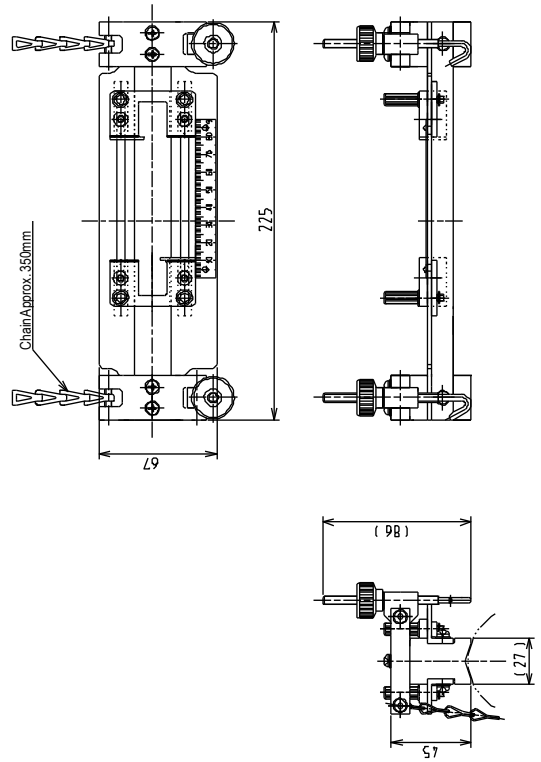

Fixture for small transducer

5-3. Medium Transducer Kit

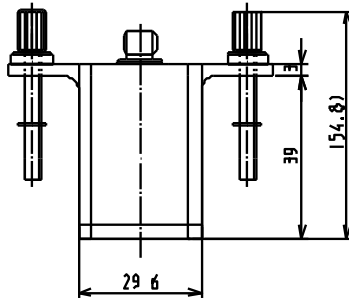
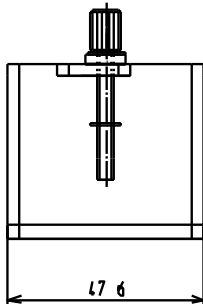
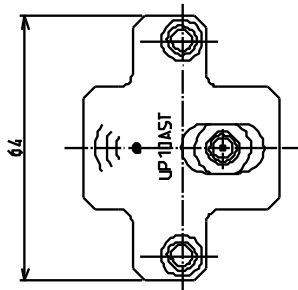

Medium transducer

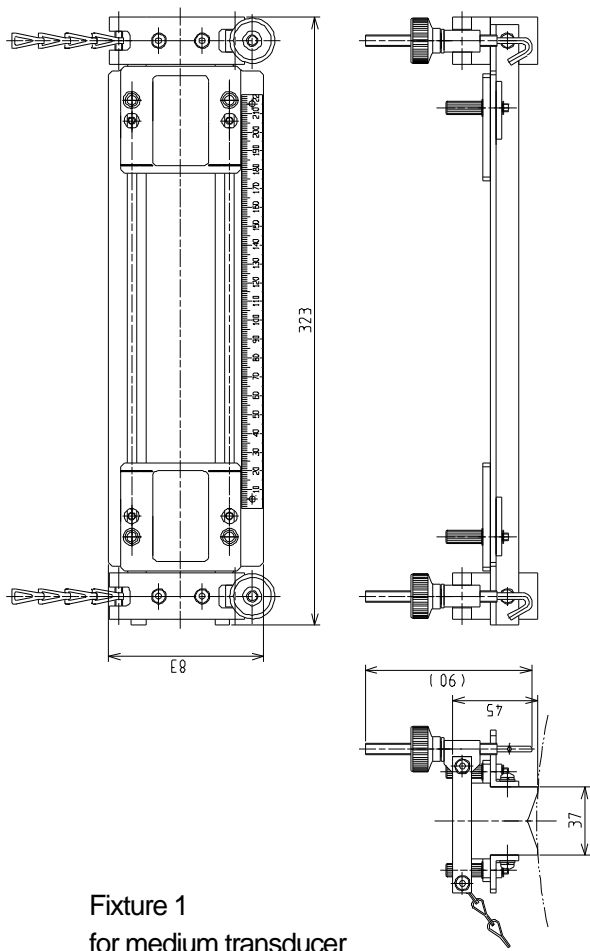

Fixture 1
for medium transducer

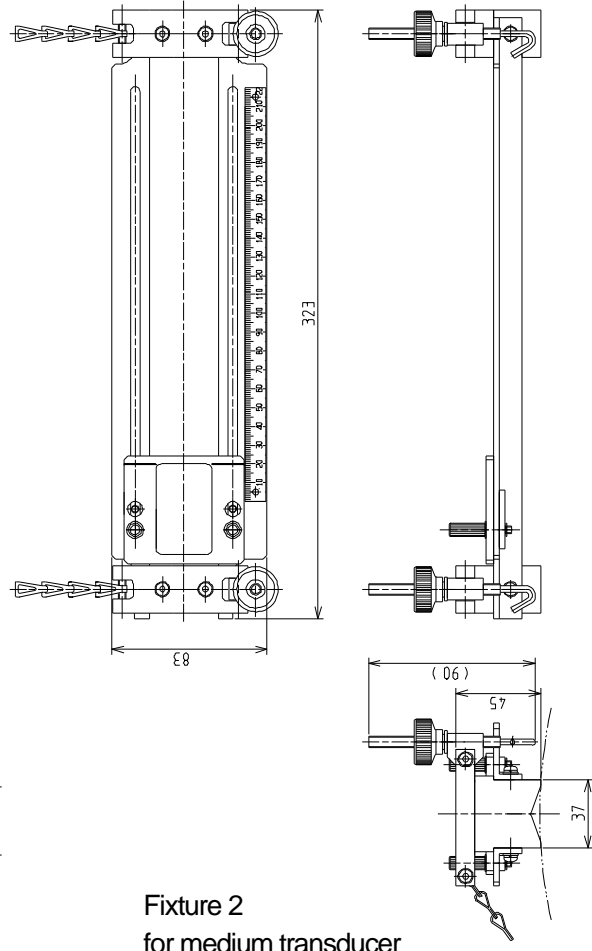

Fixture 2
for medium transducer

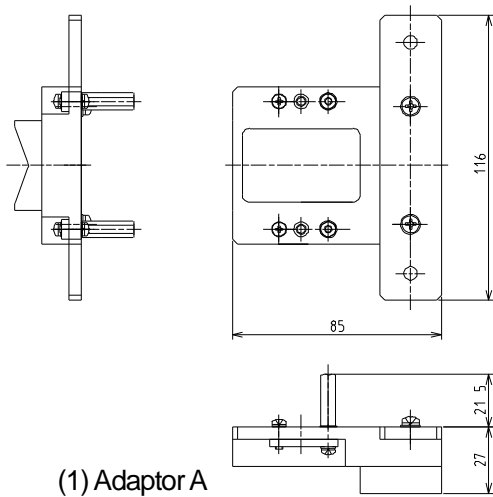

(1) Adaptor A

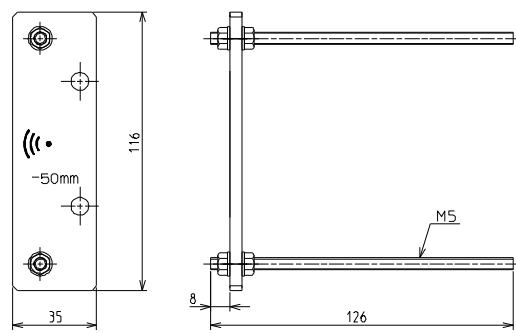

(2) Adaptor B

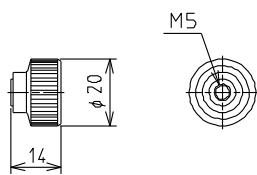

(3) Knob

Z-path method adaptor
for medium transducer

5-4. Large Transducer Kit

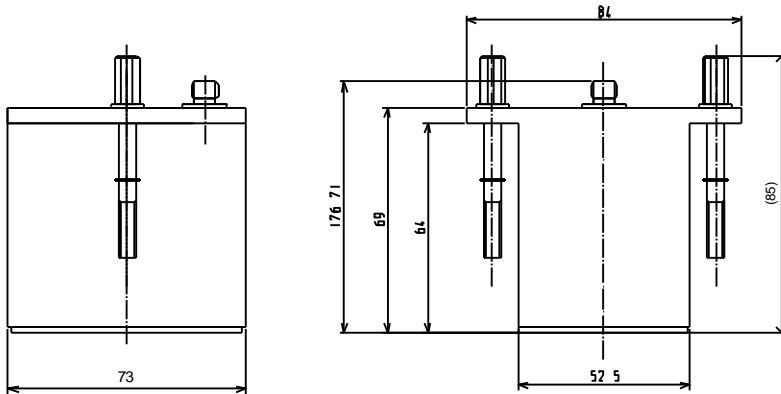
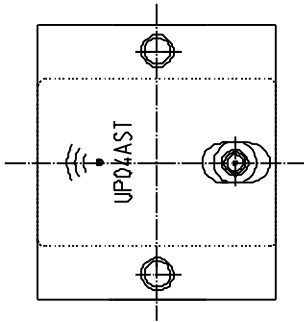

Large transducer

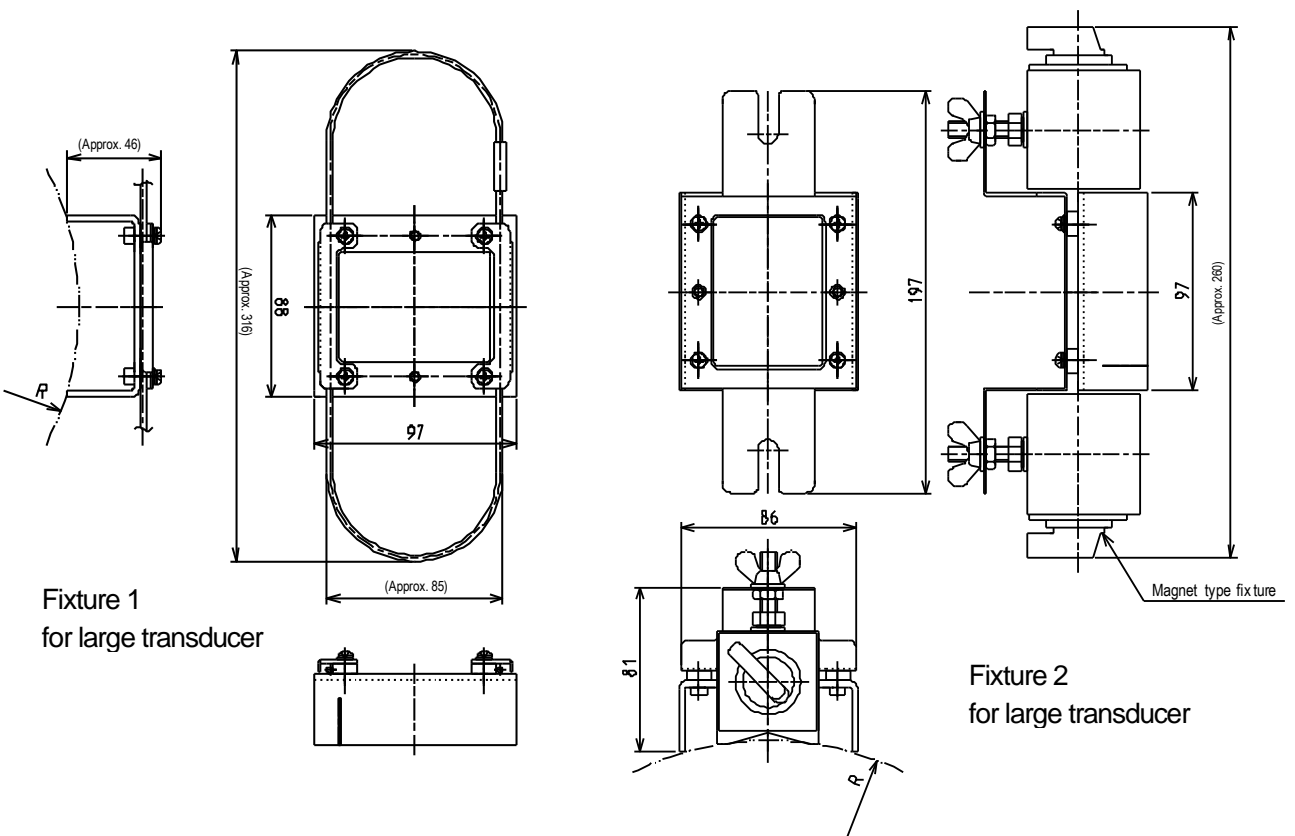

Fixture 1
for large transducer

Fixture 2
for large transducer

6. Flow and Average Flow Velocity

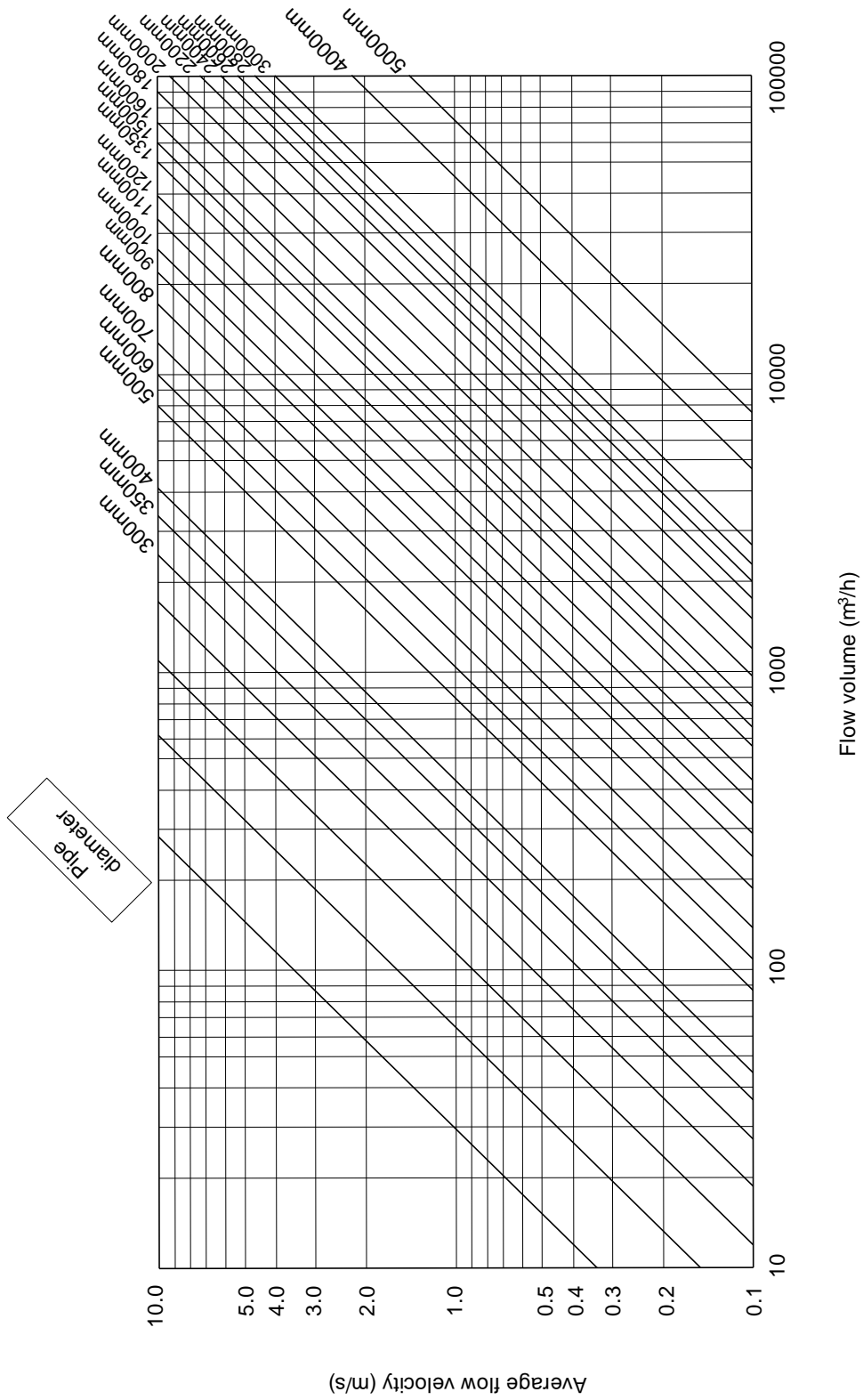

• Specifications and dimensions noted may be subject to change

7. Pipe conditions and required straight pipe length

[Refer to JEMIS 032-1987.]

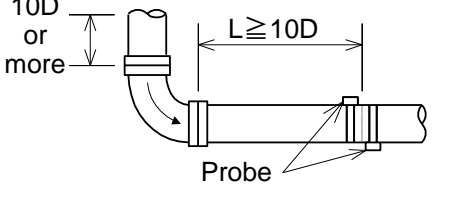
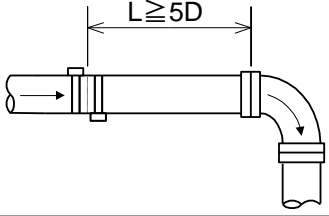
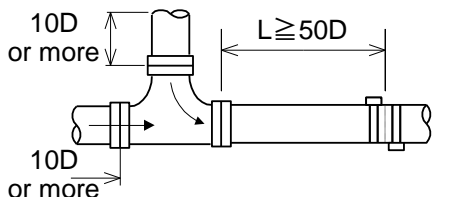
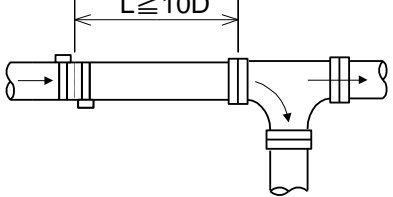
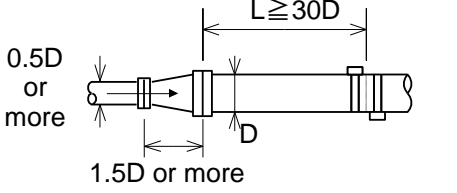
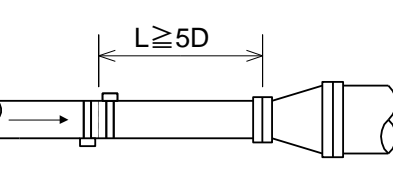
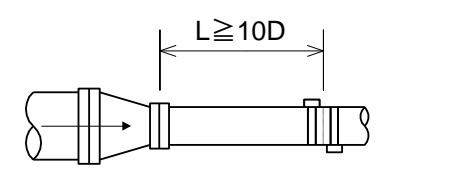
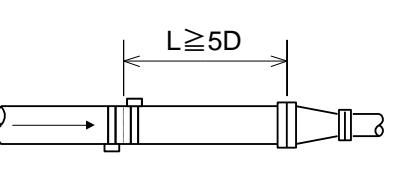
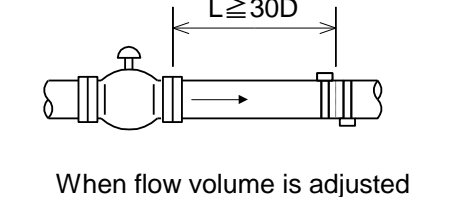
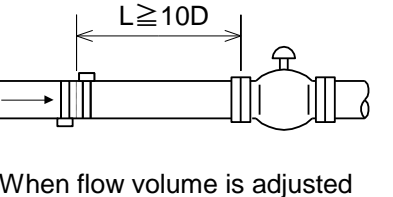
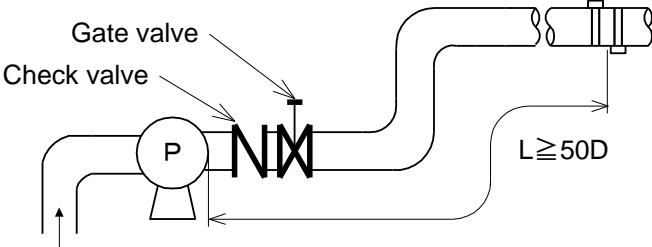
Section	Upstream straight pipe length	Downstream straight pipe length
90° bend	 <p>10D or more</p> <p>$L \geq 10D$</p> <p>Probe</p>	 <p>$L \geq 5D$</p>
T	 <p>10D or more</p> <p>$L \geq 50D$</p> <p>10D or more</p>	 <p>$L \geq 10D$</p>
Expanding pipe	 <p>0.5D or more</p> <p>$L \geq 30D$</p> <p>1.5D or more</p> <p>D</p>	 <p>$L \geq 5D$</p>
Contracting pipe	 <p>$L \geq 10D$</p>	 <p>$L \geq 5D$</p>
Various valves	 <p>$L \geq 30D$</p> <p>When flow volume is adjusted at the upstream valve.</p>	 <p>$L \geq 10D$</p> <p>When flow volume is adjusted at the downstream valve.</p>
Pump	 <p>Gate valve</p> <p>Check valve</p> <p>P</p> <p>$L \geq 50D$</p>	

[D: pipe diameter]

Required parameters for Inquiry

AA. Pipe Information

1) Process Name : _____

2) Line Quantity : _____ Lines(s)/Location(s)

3) Pipe Specification: If possible, send us DWG of pipe diagrams. _____

Diameter Nominal : DN _____ (mm) / Out Diameter _____ mm

Pipe Material : _____ / Thickness _____ mm

Lining Material : (if any) _____ mm / Thickness _____ mm

4) Required cable length: From Main Unit to Transducer _____ m

5) Straight Pipe-run : From _____, _____ folds (times) for upstream side

: From _____, _____ folds (times) for downstream side

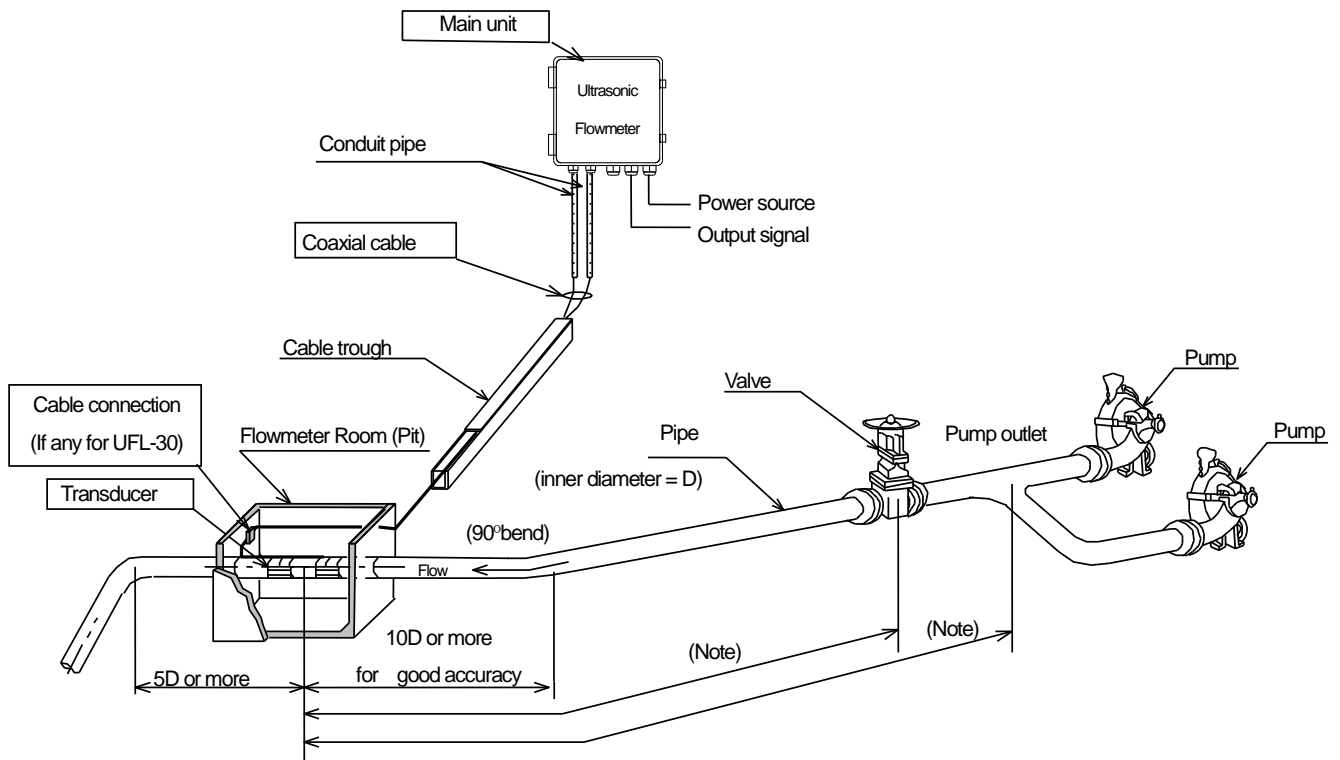

BB. Liquid Information

1) Liquid Name : _____ (main component, if any)

2) Sound Speed of Liquid: (if liquid is special and identified) _____ m/s

3) Liquid viscosity : (if liquid is special and identified) _____ m²/s

4) Temperature : _____ C deg.- _____ C deg.

CC. Extra Information

1) End user name : _____

2) Atmospheric conditions : Non-Hazardous / Hazardous requirement (_____)

3) Purpose of process : _____

4) Existing Flow instruments : (if any) _____

5) Any other problems at Flow : (if any) _____

TOKYO KEIKI INC.

2-16-46, Minami-kamata, Ohta-ku,
Tokyo 144-8551
Japan

Measurement Systems Company

Phone : +81-(0)3-3737-8664
Facsimile : +81-(0)3-3737-8665

MAY2023/PDS006Q