



Ultrasonic Flow Meter User Manual UFM400



Contents

Installation Procedure	2
1. Products Categories	2
1.1 Composition of Ultrasonic flow meter	2
1.2 Converters	2
1.3 Types of Flow/Temperature transducers	3
2. Check Components	3
3. Measuring Diagrams	4
4. Converter Installation and Wiring Diagram	4
5. Transducer Introduction and Wiring Diagram	5
5.1 Clamp on type transducer	5
6. Display and Operation	6
6.1 Display and keyboard	6
6.2 Operation	6
6.3 Menu Details	7
6.4 Quick setup of measured parameters	17
7. Transducers Installation	18
7.1 Choose installation points	18
7.2 Clamp on transducer Installation	20
7.3 Insertion type transducer installation	23
7.4 In-line type transducer installation	28
7.5 Check Installation	29
8. Finish Installation	30

Welcome to use the new generation ultrasonic flow meter made of our patented technology. UFM400 Series Ultrasonic Flow/Heat Meters utilize the transit-time principle to measure the velocity of relatively clean liquids in full pipes.

The purpose of this guide is to provide installation procedures and basic operating instructions for UFM400 Series Ultrasonic Flow/Heat Meters.

Note: Clamp on type transducer cannot be used for ductile iron pipelines

Installation Procedure

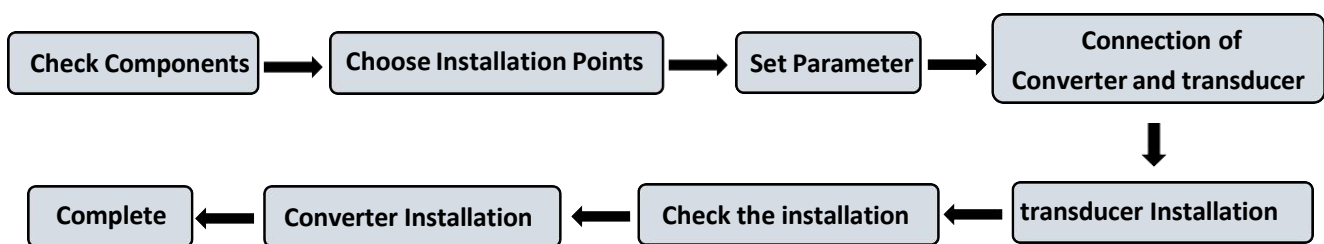

1. Products Categories

1.1 Composition of Ultrasonic flow meter





Ultrasonic Flow meter = Converter + transducer





1.2 Converters

Portable & printing Type
Model: UFM400



1.3 Types of Flow/Temperature transducers

Flow transducer	Picture	Model	Measuring range	Temperature
Clamp on		TS-2 (small)	DN25-100	-30 ~ 90°C
		TM-1 (medium)	DN50-700	
		TL-1 (large)	DN300-6000	
High temp. Clamp on		TS-2-HT (small)	DN25-100	-30 ~ 160°C
		TM-1-HT (medium)	DN50-700	
		TL-1-HT (large)	DN300-6000	
Insertion		TC-1 (standard)	DN50-6000	-30 ~ 160°C
		TC-2 (extended)		
		TP-1 (parallel)	DN80-6000	
Inline		Standard	DN15-1000	-30 ~ 160°C

Temperature transducer	Picture	Model	Measuring range	Temperature	Cutoff water
Clamp on		CT-1	DN50-6000	-40 ~ 160°C	No need
Insertion		TCT-1	DN50-6000	-40 ~ 160°C	Need
Insertion under pressure		PCT-1	DN50-6000	-40 ~ 160°C	No need
Insertion small sizes		SCT-1	< DN50	-40 ~ 160°C	Need

2. Check Components

1. Please check you have all the components in the order.
2. All codes on the converter and transducers should be matched. They are used in sets.

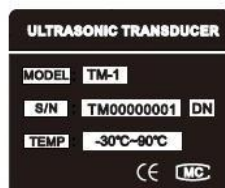
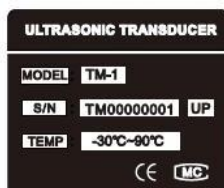

3. Measuring Diagrams

Portable type

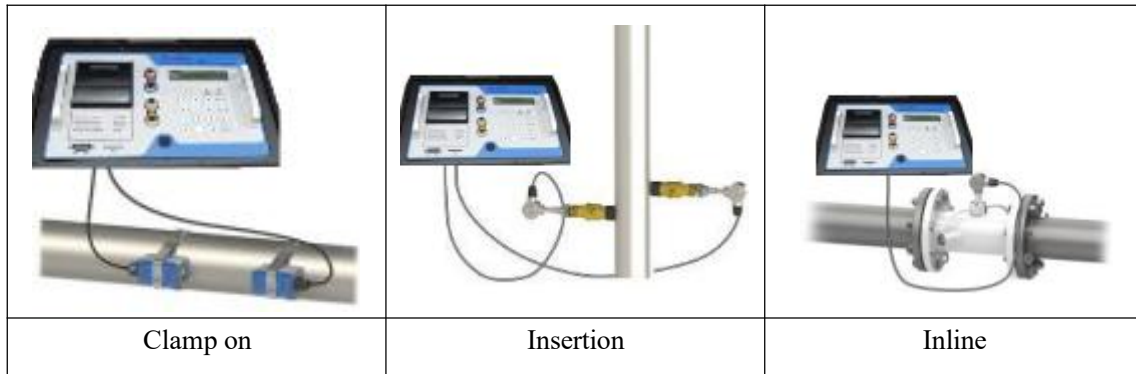

★ Temperature and heat can be measured by connecting PT100 temperature sensors on both water supply and return pipes.

4. Converter Installation and Wiring Diagram

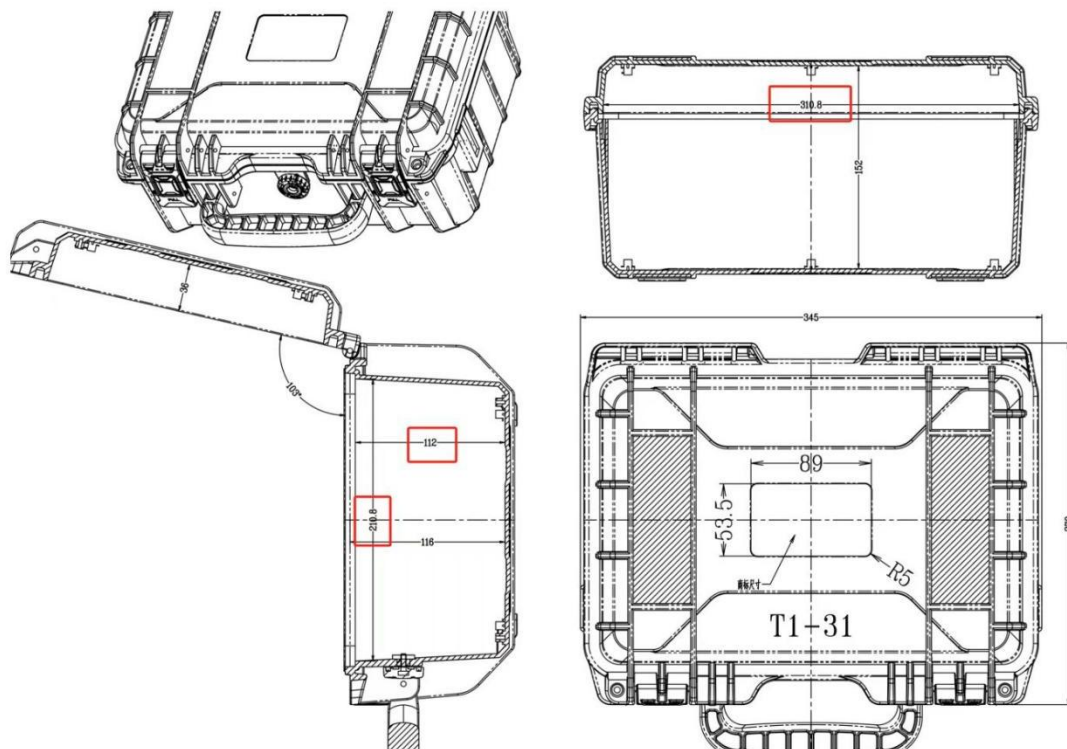

5. Transducer Introduction and Wiring Diagram

5.1 Clamp on type transducer

- Introduction

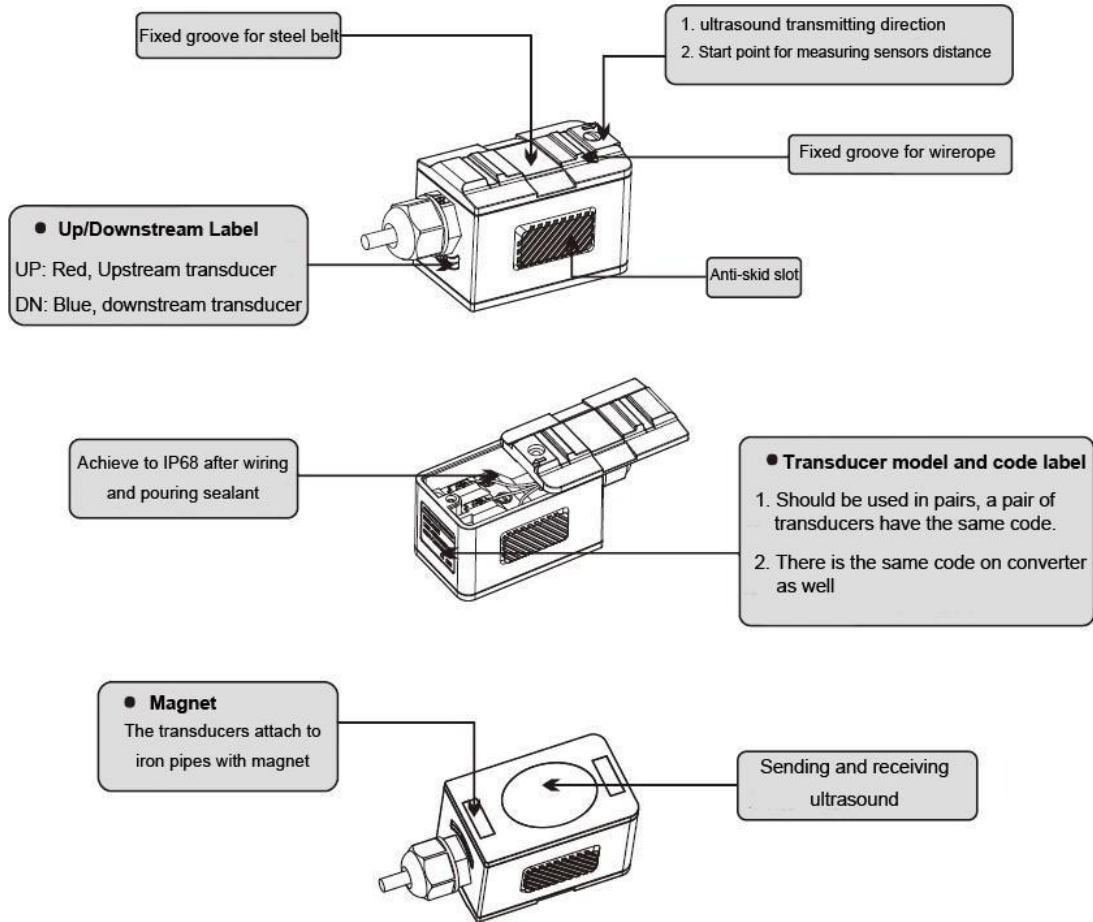

- Wiring Diagram

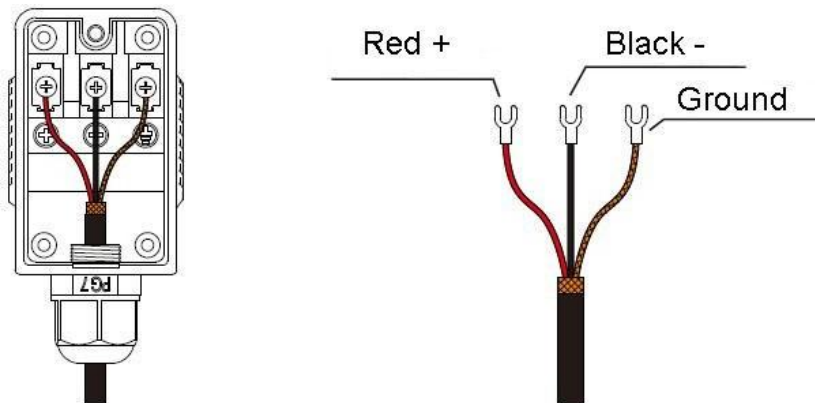

6. Display and Operation

6.1 Display and keyboard

Display is 2×20 characters LCD with backlight, available to set backlight time and contrast.

- 16-key Keyboard

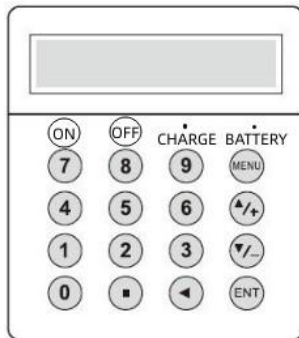

Separated Mounting

0 - 9 and . are used for inputting numbers or menu numbers.

◀ is used for back left or delete the left character.

▲/+ and ▼/- are used for entering into the last and next menu. Also can be used as ± sign when inputting numbers.

MENU is used for accessing the menu. Press this key first, then type the number keys to enter into the matched menu.

ENT is the ENTER key, used for confirming the contents you input or choose.

ON is open OFF is closed

Charge: Charging indicator light Battery: battery indicator

6.2 Operation

The user interface of this flow meter comprises about 100 different menu windows that are numbered by M00, M01, M02 ... M99.

Method to enter Menu: Press MENU first, and follow the two-digit number keys. Take M35 as an example, the correct key sequence is MENU35

To move between the adjacent menus, press ▲/+ and ▼/- for 16-key keyboard; press ▲ and

▶ for 4-key keyboard.

6.3 Menu Details

Menu No.	Function
M00	Display flow rate and NET totalizer. If the net totalizer is turned off(refer to M34), the net totalizer value shown on the screen is the value prior to its turn off. Select all totalizer unit in menu M31.
M01	Display flow rate, velocity.
M02	Display flow rate and POS(positive) totalizer. If the positive totalizer is turned off, the positive totalizer value shown on the screen is the value prior to its turn off.
M03	Display flow rate and NEG(negative) totalizer. If the negative totalizer is turned off, the negative totalizer value shown on the screen is the value prior to its turn off.
M04	Display date and time, flow rate. The date and time setting method is found in MENU60.
M05	Display energy rate(instantaneous Caloric)and total energy (Caloric).
M06	Display temperatures, inlet T1, outlet T2.
M07	Display analog inputs, AI3/AI4, current value and its corresponding temperature or pressure or liquid level value.
M08	Display all the detailed error codes. Display working condition and system error codes. 'R' stands for normal; others refer to Chapter 5 for details.
M09	Display today's total NET flow.
M10	Window for entering the outer perimeter of the pipe. If pipe outer diameter is known, skip this menu and go to Menu 11 to enter the outer diameter.
M11	Window for entering the outer diameter of the pipe. Valid range:0 to 18000mm. Note: you just need to enter either the outer diameter in M11 or the perimeter in M10.
M12	Window for entering pipe wall thickness You may skip the menu and enter inner diameter in M13 instead.
M13	Window for entering the inner diameter of the pipe If pipe outer diameter and wall thickness are enter correctly, the inner diameter will be calculated automatically, thus no need to change anything in the window
M14	Window for selecting pipe material Standard pipe materials (No need to enter material sound speed) include: (0) carbon steel (1) stainless steel (2) cast iron (3) copper (4) PVC (5) aluminum (6) asbestos (7) fiberglass (9) other(need to enter material sound speed in M15)
M15	Window for entering the pipe material speed, only for non-standard pipe materials

M16	<p>Window for selecting the liner material, select none for pipes without any liner.</p> <p>Standard liner materials(no need to enter the liner sound speed) include:</p> <p>(0) None, No liner (1) Tar Epoxy (2) Rubber (3) Mortar (4) Polypropylene (5) Polystyrol (6)Polystyrene (7) Polyester (8) Polyethylene (9) Ebonite (10) Teflon</p> <p>(11) Other (need to enter liner sound speed in M17)</p>
M17	Window for entering the non-standard liner material speed.
M18	Window for entering the liner thickness, if there is a liner
M19	Window for entering the ABS thickness of the inside wall of the pipe
M20	<p>Window for selecting fluid type</p> <p>For standard liquids(no need to enter fluid sound speed) include:</p> <p>(0) Water (1) Sea Water (2) Kerosene (3) Gasoline (4) Fuel oil (5) Crude Oil (6) Propane at -45C (7) Butane at 0C</p> <p>(8)Other liquids(need to enter sound speed in M21 and viscosity in M22)</p> <p>(9) Diesel Oil (10)Caster Oil (11)Peanut Oil (12) #90 Gasoline (13) #93 Gasoline (14) Alcohol (15) Hot water at 125C</p>
M21	Window for entering the sound speed of non- standard liquid, used only when option item 8 ‘Other’ is selected in M20
M22	Window for entering the viscosity of the non-standard liquids, used only when option item 8 ‘Other’ is selected in M20
M23	<p>Window for selecting transducer type, There are 22 types as following</p> <ol style="list-style-type: none"> 0. Standard-M (The middle size) 1. Insertion Type C 2. Standard-S 3. User Type 4. Standard B 5. Insertion Type B(45) 6. Standrad-L (The large size transducers) 7. JH-Polysonics 8. Standard-HS (small size transducer for UFM400) 9. Standard-HM (middle size transducer for Portable flow meter) 10. Standard-M1 (middle size transducer #1) 11. Standard-S1 (small size transducer #1) 12. Standard-L1 (large size transducer #1) 13. PI-Type 14. FS410 (middle size transducer for FUJI flow meter) 15. FS510 (large size transducer for FUJI flow meter) 16. Clamp-on TM-1 (Middle size transducer for Taosonics Instrument) 17. Insertion TC-1 (for Taosonic Instrument) 18. Calmp-on TS-1 (small size for Taosonics Instrument) 19. Calmp-on TS-1 20. Clamp-on TL-1 (For Taosonics Instrument) 21. Insertion TLC-2 (For Taosonics Instrument) 22. Clamp-on M2 23. Clamp-on L2 <p>If the user-type-transducer is selected, you need enter additional 4 user-type-wedge parameters that describe the user transducers.</p> <p>If the PI-type transducer is selected, you need enter additional 4 PI-type transducer parameters that describe the PI-type transducers</p>

M24	<p>Window for selecting the transducer mounting methods</p> <p>Four methods can be selected: (0) V-method (1) Z-method (2) N-method (3) W-method</p>																								
M25	<p>Display the transducer mounting spacing or distance</p>																								
M26	<p>(1) A switch for the parameters in flash memory will be loaded when power is turned on. The default option is that the parameters will be loaded. If this switch is not turned on, the system will try to use the parameters in the system RAM, if these parameters are ok, otherwise the system will load the parameters in flash memory</p> <p>(2) Function to store the current parameters into the flash memory, so that these parameters will be solidified and will be loaded as the default parameters every time when power is turned on.</p>																								
M27	<p>Entry to store to or restore from the internal Flash memory, as many as 9 different pipe parameter configurations</p> <p>To save or load the current setup parameter, use the going up or going down keys to change the address number, press 'ENT' key, and use going down or going up keys to select to save to or load from the memory.</p>																								
M28	<p>Entry to determine whether or not to hold (or to keep) the last good value when poor signal condition occurs. YES is the default setup.</p>																								
M29	<p>Entry to setup empty signal threshold. When the signal is less than this threshold, the pipe is regarded as empty pipe, and the flow meter will not totalize flow.</p> <p>This is based on the fact that, for most occasions, when pipe is empty, the transducer would still receive signal, just smaller than normal, As a result, The flow meter would show normal operation, which is not correct.</p> <p>Make sure that the entered value must be less than the normal signal strength.</p> <p>When much noisy signals are received, to make sure the flow meter will not incorrectly totalize flow, there is also a 'Q' threshold should be entered in M.5</p>																								
M30	<p>Window for selecting unit system. The conversion English to Metric or vice versa will not affect the unit for totalizers.</p>																								
M31	<p>Window for selecting flow rate unit system.</p> <p>Flow rate can be in</p> <table border="0"> <tr> <td>0. Cubic meter</td> <td>short for</td> <td>(m³)</td> </tr> <tr> <td>1. Liter</td> <td></td> <td>(l)</td> </tr> <tr> <td>2. USA gallon</td> <td></td> <td>(gal)</td> </tr> <tr> <td>3. Imperial Gallon</td> <td></td> <td>(igl)</td> </tr> <tr> <td>4. Million USA gallon</td> <td></td> <td>(mgl)</td> </tr> <tr> <td>5. Cubic feet</td> <td></td> <td>(cf)</td> </tr> <tr> <td>6. USA liquid barrel</td> <td></td> <td>(bal)</td> </tr> <tr> <td>7. Oil barrel</td> <td></td> <td>(ob)</td> </tr> </table> <p>The flow unit in terms of time can be per day, per hour, per minute or per second. So there are 32 different flow rate units in total for selection.</p>	0. Cubic meter	short for	(m ³)	1. Liter		(l)	2. USA gallon		(gal)	3. Imperial Gallon		(igl)	4. Million USA gallon		(mgl)	5. Cubic feet		(cf)	6. USA liquid barrel		(bal)	7. Oil barrel		(ob)
0. Cubic meter	short for	(m ³)																							
1. Liter		(l)																							
2. USA gallon		(gal)																							
3. Imperial Gallon		(igl)																							
4. Million USA gallon		(mgl)																							
5. Cubic feet		(cf)																							
6. USA liquid barrel		(bal)																							
7. Oil barrel		(ob)																							
M32	<p>Window for selecting the totalizers unit. Available units are the same as those in M31</p>																								
M33	<p>Window for setting the totalizer multiplying factor</p> <p>The multiplying factor ranges from 0.001 to 10000. Factory default is 1</p>																								
M34	<p>Turn on or turn off the NET totalizer</p>																								
M35	<p>Turn on or turn off the POS (positive) totalizer</p>																								

M36	Turn on or turn off the NEG(negative) totalizer
M37	(1) Totalizer reset (2) Restore the factory default settings parameters. Press the dot key followed by the backspace key. Attention, It is recommended to make note on the parameters before doing the restoration
M38	Manual totalizer used for easier calibration. Press a key to start and press a key to stop the manual totalizer.
M39	Language selection. The selection could also be changed automatically by the system, if English LCD display is used as the display device.
M3A	Setup for local segmental LCD display. Enter 0 or 1 for the non-auto-scan mode; Enter 2~39 for the auto-scan mode. In the auto-scan mode the display will automatically scan displaying from 00 to the entered number of the local segmental LCD display.
M40	Flow rate damper for a stable value. The damping parameter ranges from 0 to 999 seconds. 0 means there is no damping. Factory default is 10 seconds
M41	Low flow rate (or zero flow rate) cut-off to avoid invalid accumulation.
M42	Zero calibration/Zero point setup. Make sure the liquid in the pipe is not running while doing the setup.
M43	Clear the zero point value, and restore the solidified zero point value.
M44	Set up a flow bias. Generally this value should be 0.
M45	Flow rate scale factor. The default value is '1'. Keep this value as '1', when no calibration has been made.
M46	Networks address identification number. Any integer can be entered except 13(0DH, carriage return), 10 (0AH, line feeding), 42 (2AH), 38, 65535. Every set of the instrument in a network environment should have a unique IDN. Please refer to the chapter for communication.
M47	System locker to avoid modification of the system parameters. If password is forgotten, you could send a command 'LOCK0' to the serial input to unlock. Or you can write 0 to REGISTER49-50 under MODBUS protocol.
M48	Entry to linearity correcting data inputs. By using of this function, the non-linearity of flow meter will be corrected. Correcting data shall be obtained by careful calibration.
M49	Displays the input contents for the serial port. By checking the displays, you can know if the communication is ok.
M50	Switches for the built-in data logger. There are as many as 22 different items can be chosen. To turn this function, select 'YES' the system will ask for selecting the items. There are 22 items available. Turn on all those items you want to output
M51	Window to setup the time of scheduled output function (data logger, or Thermo-printer). This includes start time, time interval and how many times of output. When a number great than 8000 entered for the times of output, It means the output will be keeping always. The minimum time interval is 1 second and the maximum is 24 hours.
M52	Data logging direction control. (1) If 'Send to RS485' is selected, all the data produced by the data logger will be transmitted out through the RS-232/RS485 interface (2) If 'To the internal serial BUS is selected, the data will be transmitted to the internal serial bus which allows a thermal printer, or a 4-20mA analog output

	module, to be connected to it.
M53	Display analog inputs, AI5, current value and its corresponding temperature or pressure or liquid level value.
M54	Pulse width setup for the OCT (OCT1) output. Minimum is 6 mS, maximum is 1000 mS
M55	Select analog output (4-20mA current loop, or CL) mode. Available options: (0) 4-20mA output mode (setup the output range from 4-20mA) (1) 0-20mA output mode (setup the output range from 0-20mA, This mode can only be used with Version-15 flow meter) (2) RS232 Serial port controls 0-20mA (3) 4-20mA corresponding fluid sound speed (4) 20-4-20mA mode (5) 0-4-20mA mode (can only be used with Version-15 flow meter) (6)20-0-20mA mode(can only be used with Version-15 flow meter) (7) 4-20mA corresponding flow velocity (8)4-20mA corresponding heat flow rate
M56	4mA or 0mA output value, Set the value which corresponds to 4mA or 0mA output current (4mA or 0mA is determined by the setting in M55)
M57	20mA output value, Set the value which corresponds to 20mA output current
M58	Current loop verification Check if the current loop is calibrated correctly.
M59	Display the present output of current loop circuit.
M60	Setup system date and time. Press ENT for modification. Use the dot key to skip the digits that need no modification.
M61	Display Version information and Electronic Serial Number (ESN) that is unique for each flow meter. The users may employ the ESN for instrumentation management
M62	RS-232/RS485 setup. All the devices connected with flow meter should have matched serial configuration. The following parameters can be configured: Baud rate (300 to 19200 bps), parity, data bits (always is 8), stop bits (1).
M63	Select communication protocol. Factory default is 'MODBUS ASCII. this is a mode for MODBUS-ASCII, Meter-BUS, Fuji Extended Protocol, Huizhong's various protocols. If you are going using MODBUS-RTU you have to select 'MODBUS_RTU'.
M64	AI3 value range. Used to enter temperature/pressure values that are corresponding to 4mA and 20mA input current. The display values have no unit, so that they can present any physical parameter.
M65	AI4 value range. Used to enter temperature/pressure values that are corresponding to 4mA and 20mA input current.

M66	<p>AI5 value range.</p> <p>Used to enter temperature/pressure values that are corresponding to 4mA and 20mA input current.</p>																											
M67	<p>Windows to setup the frequency range (lower and upper limit) for the frequency output function. Valid range is 0Hz-9999Hz. Factory default value is 0-1000 Hz.</p> <p>For Version-12, Version-13, Version-14 flow meters, you need a hardware module, which shall be plugged to the Serial Expanding Bus, for the frequency output function. Please remember to order the module if you need frequency output function.</p> <p>For Version-15 flow meter, you need to indicate on your orders that you need the frequency function; Otherwise you will get a flow meter which has no frequency output circuits.</p>																											
M68	<p>Window to setup the minimum flow rate value which corresponds to the lower frequency limit of the frequency output.</p>																											
M69	<p>Windows to setup the maximum flow Rate value that corresponds to the upper frequency limit of the frequency output.</p>																											
M70	<p>LCD display backlight control. The entered value indicates how many seconds the backlight will be on with every key pressing. If the enter value is great than 50000 seconds, It means that the backlight will always keeping on.</p>																											
M71	<p>LCD contrast control. The LCD will become darker or brighter when a value is entered.</p>																											
M72	<p>Working timer. It can be cleared by pressing ENT key, and then select YES.</p>																											
M73	<p>Window to setup the lower limit of flow rate for Alarm#1.</p> <p>When the flow rate is below the set value, Alarm#1 equals 'on'</p>																											
M74	<p>Window to setup the upper limit of flow rate for Alarm#1.</p> <p>When the flow rate is above the set value, Alarm#1 equals 'on'</p> <p>There are two alarms in the flow meter, and every alarm can be pointed to alarm output devices such as the BUZZER or OCT output or RELAY output. For example, if you want the Alarm#1 is to output by the OCT circuit, you need to set M78 at selection item 6.</p>																											
M75	<p>Window to setup the lower limit of flow rate for Alarm#2.</p>																											
M76	<p>Window to setup the upper limit of flow rate for Alarm#2.</p>																											
M77	<p>Buzzer setup.</p> <p>If a proper input source is selected, the buzzer will beep when the trigger event occurs. The available trigger sources are:</p> <table border="0"> <tr> <td>0. No Signal</td> <td>1. Poor Signal</td> <td></td> </tr> <tr> <td>2. Not Ready (No*R)</td> <td>3. Reverse Flow</td> <td>4. AO Over 100%</td> </tr> <tr> <td>5. FO Over 120%</td> <td>6. Alarm #1</td> <td>7. Reverse Alarm #2</td> </tr> <tr> <td>8. Batch Controller</td> <td>9. POS Int Pulse</td> <td>10.NEG Int Pulse</td> </tr> <tr> <td>11.NET Int Pulse</td> <td>12.Energy POS Pulse</td> <td>13.Energy NEG Pulse</td> </tr> <tr> <td>14.Energy NET Pulse</td> <td>15.MediaVel=>Thresh</td> <td>16.MediaVelo<Thresh</td> </tr> <tr> <td>17.ON/OFF viaRS485</td> <td>18.Daily Timer (M51)</td> <td>19.Timed alarm #1</td> </tr> <tr> <td>20. Timed alarm #2</td> <td>21.Batch Total Full</td> <td>22. Timer by M51</td> </tr> <tr> <td>23. Batch 90% Full</td> <td>24. Key Stroking ON</td> <td>24.Disable BEEPER</td> </tr> </table>	0. No Signal	1. Poor Signal		2. Not Ready (No*R)	3. Reverse Flow	4. AO Over 100%	5. FO Over 120%	6. Alarm #1	7. Reverse Alarm #2	8. Batch Controller	9. POS Int Pulse	10.NEG Int Pulse	11.NET Int Pulse	12.Energy POS Pulse	13.Energy NEG Pulse	14.Energy NET Pulse	15.MediaVel=>Thresh	16.MediaVelo<Thresh	17.ON/OFF viaRS485	18.Daily Timer (M51)	19.Timed alarm #1	20. Timed alarm #2	21.Batch Total Full	22. Timer by M51	23. Batch 90% Full	24. Key Stroking ON	24.Disable BEEPER
0. No Signal	1. Poor Signal																											
2. Not Ready (No*R)	3. Reverse Flow	4. AO Over 100%																										
5. FO Over 120%	6. Alarm #1	7. Reverse Alarm #2																										
8. Batch Controller	9. POS Int Pulse	10.NEG Int Pulse																										
11.NET Int Pulse	12.Energy POS Pulse	13.Energy NEG Pulse																										
14.Energy NET Pulse	15.MediaVel=>Thresh	16.MediaVelo<Thresh																										
17.ON/OFF viaRS485	18.Daily Timer (M51)	19.Timed alarm #1																										
20. Timed alarm #2	21.Batch Total Full	22. Timer by M51																										
23. Batch 90% Full	24. Key Stroking ON	24.Disable BEEPER																										

<p>M78</p>	<p>OCT (Open Collect Transistor Output)/OCT1 setup</p> <p>By selecting a proper input source, the OCT circuit will close when the trigger event occurs. The available trigger sources are:</p> <table border="0"> <tr> <td>0. No Signal</td> <td>1. Poor Signal</td> </tr> <tr> <td>2. Not Ready(No*R)</td> <td>3. Reverse Flow</td> </tr> <tr> <td>4. AO Over 100%</td> <td>5. FO Over 120%</td> </tr> <tr> <td>6. Alarm #1</td> <td>7. Reverse Alarm #2</td> </tr> <tr> <td>8. Batch Controller</td> <td>9. POS Int Pulse</td> </tr> <tr> <td>10.NEG Int Pulse</td> <td>11.NET Int Pulse</td> </tr> <tr> <td>12.Energy POS Pulse</td> <td>13.Energy NEG Pulse</td> </tr> <tr> <td>14.Energy NET Pulse</td> <td>15.MediaVel=>Thresh</td> </tr> <tr> <td>16.MediaVelo<Thresh</td> <td>17.ON/OFF viaRS485</td> </tr> <tr> <td>18. Daily Timer (M51)</td> <td>19.Timed alarm #1</td> </tr> <tr> <td>20. Timed alarm #2</td> <td>21.Batch Total Full</td> <td>22.Timer by M51</td> </tr> <tr> <td>23.Batch 90% Full</td> <td>24.Flow Rate Pulse</td> <td>25.Disable OCT</td> </tr> </table> <p>The OCT circuit does not source voltage at its output. It must be connected with an external power and pull-up resistant for some occasions.</p> <p>When the OCT circuit is close, it will draw current. The maximum current shall not be over 100mA.</p> <p>Attention: the maximum voltage applied to OCT can not be over 80 volts.</p>	0. No Signal	1. Poor Signal	2. Not Ready(No*R)	3. Reverse Flow	4. AO Over 100%	5. FO Over 120%	6. Alarm #1	7. Reverse Alarm #2	8. Batch Controller	9. POS Int Pulse	10.NEG Int Pulse	11.NET Int Pulse	12.Energy POS Pulse	13.Energy NEG Pulse	14.Energy NET Pulse	15.MediaVel=>Thresh	16.MediaVelo<Thresh	17.ON/OFF viaRS485	18. Daily Timer (M51)	19.Timed alarm #1	20. Timed alarm #2	21.Batch Total Full	22.Timer by M51	23.Batch 90% Full	24.Flow Rate Pulse	25.Disable OCT
0. No Signal	1. Poor Signal																										
2. Not Ready(No*R)	3. Reverse Flow																										
4. AO Over 100%	5. FO Over 120%																										
6. Alarm #1	7. Reverse Alarm #2																										
8. Batch Controller	9. POS Int Pulse																										
10.NEG Int Pulse	11.NET Int Pulse																										
12.Energy POS Pulse	13.Energy NEG Pulse																										
14.Energy NET Pulse	15.MediaVel=>Thresh																										
16.MediaVelo<Thresh	17.ON/OFF viaRS485																										
18. Daily Timer (M51)	19.Timed alarm #1																										
20. Timed alarm #2	21.Batch Total Full	22.Timer by M51																									
23.Batch 90% Full	24.Flow Rate Pulse	25.Disable OCT																									
<p>M79</p>	<p>Relay or OCT2 setup</p> <p>By selecting a proper input source, the RELAY will close when the trigger event occurs</p> <p>The available trigger sources are:</p> <table border="0"> <tr> <td>0. No Signal</td> <td>1. Poor Signal</td> </tr> <tr> <td>2. Not Ready(No*R)</td> <td>3. Reverse Flow</td> <td>4. AO Over 100%</td> </tr> <tr> <td>5. FO Over 120%</td> <td>6. Alarm #1</td> <td>7. Reverse Alarm #2</td> </tr> <tr> <td>8. Batch Controller</td> <td>9. POS Int Pulse</td> <td>10.NEG Int Pulse</td> </tr> <tr> <td>11.NET Int Pulse</td> <td>12.Energy POS Pulse</td> </tr> <tr> <td>13.Energy NEG Pulse</td> <td>14.Energy NET Pulse</td> </tr> <tr> <td>15.MediaVel=>Thresh</td> <td>16.MediaVelo<Thresh</td> </tr> <tr> <td>17.ON/OFF viaRS485</td> <td>18. Timer (M51 Daily)</td> </tr> <tr> <td>19.Timed alarm #1</td> <td>20. Timed alarm #2</td> </tr> <tr> <td>21.Batch TotalFull</td> <td>22.Timer by M51</td> </tr> <tr> <td>23.Batch 90% Full</td> <td>24.Disable RELAY</td> </tr> </table> <p>The RELAY is of SPST(Single pole, single throw) type. It is rated for 110VAC max and have a current rating of 0.5A resistive load.</p> <p>It highly recommended that a salve relay to be utilized whenever a large resistive load or inductive load is to be controlled.</p> <p>Note. In order to make the user interface compatible with the former version7, the name RELAY was used other than OCT2, but in fact it is an OCT output.</p>	0. No Signal	1. Poor Signal	2. Not Ready(No*R)	3. Reverse Flow	4. AO Over 100%	5. FO Over 120%	6. Alarm #1	7. Reverse Alarm #2	8. Batch Controller	9. POS Int Pulse	10.NEG Int Pulse	11.NET Int Pulse	12.Energy POS Pulse	13.Energy NEG Pulse	14.Energy NET Pulse	15.MediaVel=>Thresh	16.MediaVelo<Thresh	17.ON/OFF viaRS485	18. Timer (M51 Daily)	19.Timed alarm #1	20. Timed alarm #2	21.Batch TotalFull	22.Timer by M51	23.Batch 90% Full	24.Disable RELAY	
0. No Signal	1. Poor Signal																										
2. Not Ready(No*R)	3. Reverse Flow	4. AO Over 100%																									
5. FO Over 120%	6. Alarm #1	7. Reverse Alarm #2																									
8. Batch Controller	9. POS Int Pulse	10.NEG Int Pulse																									
11.NET Int Pulse	12.Energy POS Pulse																										
13.Energy NEG Pulse	14.Energy NET Pulse																										
15.MediaVel=>Thresh	16.MediaVelo<Thresh																										
17.ON/OFF viaRS485	18. Timer (M51 Daily)																										
19.Timed alarm #1	20. Timed alarm #2																										
21.Batch TotalFull	22.Timer by M51																										
23.Batch 90% Full	24.Disable RELAY																										

<p>M80</p>	<p>Window for selecting the trigger signal for the built-in batch controller. Available trig sources:</p> <ul style="list-style-type: none"> 0. Key input (press ENT key to start the batch controller) 1. Serial port 2. AI3 rising edge (when AI3 receives 2mA or more current) 3. AI3 falling edge (when AI3 stop receiving 2mA or more current) 4. AI4 rising edge (when AI3 receives 2mA or more current) 5. AI4 falling edge (when AI3 stop receiving 2mA or more current) 6. AI5 rising edge (when AI3 receives 2mA or more current) 7. AI5 falling edge (when AI3 stop receiving 2mA or more current) 8. Timer periodically (define the start time and interval time in M51) 9. Timer daily (define the start time and interval time in M51) <p>For the input analog current signal, 0 mA indicates “0”, 4mA or more indicates ‘1’.</p> <p>By selecting item #8, the batch totalizer can be started periodically by the internal timer located at Menu51. When the batch totalizer is full, a signal which indicate the batch is full can be direct to either the OCT or the RELAY terminals to stop the pump or other devices.</p> <p>By selecting item #9, the batch totalizer could act as totalizer witch runs for only a period of the day so that a alarm signal could be produced if the total flow during that time period is over a certain amount of. For example, if you want a alarm signal which stand for the total flow is over 100 cubic meters during the period of every day from 20:00 to 06:00, setups is like</p> <p>M51 start time =20:00:00 M51 interval =10:00:00 M51 log times =9999 (means always) M80 select item #9 M81 input 100 (Unit is defined in M30,M31,M32)</p>
<p>M81</p>	<p>The built-in batch controller Set the flow batch value(dose) The internal output of the batch controller can be directed either to the OCT or the RELAY output circuits. M81 and M80 should be used together to configure the batch controller. Note: Because the measuring period is 500mS, the flow for every dos should be keeping at 60 seconds long to get a 1% dose accuracy.</p>
<p>M82</p>	<p>View the daily, monthly and yearly flow totalizer and thermal energy totalizer value. The totalizer values and errors for the last 64 days, 32 last 32 months and last 2 years are stored in the RAM memory, To view them, use the ‘ENT’ and ‘UP’ ‘Down’ keys.</p>
<p>M83</p>	<p>Automatic Amending Function for automatic offline compensation. Select ‘YES’ to enable this function, select ‘NO’ to disable it. When the function is enabled, The flow meter will estimate the average flow uncounted (or ‘lost’) during the offline session and add the result to the totalizer. The estimation of the uncounted flow is made by computing the product of the offline time period and the average flow rate, which is the average of the flow rate before going offline and the one after going on line.</p>

M84	Set the thermal energy unit: 0. GJ 1. KC 2.KWh 3. BTU
M85	Select temperature sources 0. from T1,T2 (factory default) 1. from AI3,AI4
M86	Select the Specific Heat Value. Factory default is 'GB'. Under this setting, the flow meter will calculate the enthalpy of water based on the international standard. If the fluid is other than water, you should select option '1. Fixed Specific Heat', and enter the specific heat value of the fluid.
M87	Turn on or turn off the Energy totalizer.
M88	Select thermal energy totalizer multiplying factor. Factory default is '1'.
M89	1. Display the temperature difference 2. Window for entering the lowest temperature difference.
M8.	Heat meter is on 1. Inlet 2. Outlet Select the heat meter installation place.
M90	Display signal strengths S (one for upstream and one for downstream), and signal quality Q value. Signal strength is presented by 00.0 to 99.9, the bigger the value, the bigger the signal strength will be, and more reliable readings will be made. Q value is presented by 00 to 99, the bigger the better. It should at least be great than 50 for normal operations.
M91	Displays the Time Ratio between the Measured Total Transit Time and the Calculated time. If the pipe parameters are entered correctly and the transducers are properly installed, the ratio value should be in the range of $100\pm 3\%$. Otherwise the entered parameters and the transducer installation should be checked.
M92	Displays the estimated fluid sound velocity. If this value has an obvious difference with the actual fluid sound speed, pipe parameters entered and the transducer installation should be checked again.
M93	Displays total transit time and delta time(transit time difference)
M94	Displays the Reynolds number and the pipe factor used by the flow rate measurement program. Pipe factor is calculated based on the ratio of the line-average velocity and the cross-section average velocity.
M95	(1) Display the positive and negative energy totalizers (2) Upon entering this window, the circular display function will be started automatically. The following windows will be displayed one by one, each window will stay for 8 seconds: M95>>M00>>M01>>M02>>M02>>M03>>M04>>M05>>M06>>M07>>M08>>M90>>M91>>M92>> M93>>M94>>M95. This function allows the user to visit all the important information without any manual action. To stop this function, simply press a key. Or switch to a window other than M95.
M96	This is not a window but a command for the thermal printer to advance 5 lines of paper.

M97	<p>This is not a window but a command to print the pipe parameters.</p> <p>By default, the produced data will be directed to the internal serial bus (thermal printer). You can also direct those data to the serial communication port.</p>
M98	<p>This is not a window but a command to print the diagnostic information.</p> <p>By default, the produced data will be directed to the internal serial bus (thermal printer). You can also direct those data to the serial communication port.</p>
M99	<p>This is not a window but a command to copy the current display window. By default, the produced data will be directed to the internal serial bus (thermal printer). You can also direct those data to the serial communication port.</p> <p>By use of the window copying function, you can hardcopy very window displaying manually by switching windows, or you can obtain the window displaying data by communication.</p>
M+0	Browse the 32 recorded instrument power-on and power-off date and time with the flow rate at the time of power on and off
M+1	<p>Displays the total working time of the flow meter.</p> <p>When the backup battery is removed, the total working time will be reset to zero.</p>
M+2	Displays the last power-off date and time
M+3	Displays the last power-off flow rate
M+4	Displays how many times of has been powered on and powered off.
M+5	<p>A scientific calculator for the convenience of field working.</p> <p>All the values are in single accuracy.</p> <p>The calculator can be used while the flow meter is conducting flow measurement.</p> <p>Water density and PT100 temperature can also be found in this function.</p>
M+6	<p>Set fluid sound speed threshold</p> <p>Whenever the estimated sound speed (displayed in M92) exceeds this threshold, an alarms signal will be generated and can transmitted to BUZZER or OCT or RELAY.</p> <p>This function can used to produce an alarm or output when fluid material changes.</p>
M+7	Displays total flow for this month(only for the time past)
M+8	Displays total flow for this year(only for the time past)
M+9	Display the not-working total time in seconds. The total failure timer will also include the time when power off, if the back-up battery is applied.
M.2	Entry to solidify the zero point. Password protected.
M.5	<p>Setup the Q value threshold.</p> <p>If the present Q is below this threshold, flow rate will be set to 0.</p> <p>This function is useful when flow meter is installed in noisy environment or on airy pipes.</p>
M.8	The maximum flow rates for today and this month.
M.9	Serial port tester with CMM command output for very second.
M-0	Entry to hardware adjusting windows only for the manufacturer
M-1	4-20mA output adjustment
M-2	4mA calibration for AI3 input
M-3	20mA calibration for AI3 input
M-4	4mA calibration for AI4 input

M-5	20mA calibration for AI4 input
M-6	4mA calibration for AI5 input
M-7	20mA calibration for AI5 input
M-8	Lower Temperature Zero setup for the PT100
M-9	Higher Temperature Zero setup for the PT100
M-A	Temperature Calibration at 50°C
M-B	Temperature Calibration at 84.5°C

6.4 Quick setup of measured parameters

Accurate measured parameters can have a great influence on measuring precision and reliability. It is suggested to measure the practical perimeter and wall thickness of the pipeline. Ultrasonic thickness gauge can be used to measure the pipe thickness.

Measured parameters setup is from Menu10 to Menu29. Please complete one by one.

>>> Following parameters need to be inputted before measurement:

1. Outer diameter unit: mm
2. Pipe thickness unit: mm
3. Pipe material
4. Lining parameters: thickness and sound velocity (If have lining)
5. Liquid type
6. transducer type
7. transducer mounting type

>> Above parameters setup generally follow the steps below:

1. Press keys **MENU 1 1** to enter M11 window to input the pipe outer diameter, and then press **ENT** key.
2. Press key **▼/–** to enter M12 window to input the pipe outer diameter and then press **ENT** key.
3. Press key **▼/–** to enter M14 window, and press **ENT** key to enter the option selection mode.
Use keys **▲/+** and **▼/–** to select the pipe material, and then press **ENT** key.
4. Press key **▼/–** to enter M16 window, press **ENT** key to enter the option selection mode. Use keys **▲/+** and **▼/–** to select the liner material, and then press ENT key. Select “No Liner”, if there is no liner.
5. Press key **▼/–** to enter M20 window, press **ENT** key to enter the option selection mode. Use keys **▲/+** and **▼/–** to select the proper liquid, and then press **ENT** key.
6. Press key **▼/–** to enter M23 window, press **ENT** key to enter the option selection mode. Use keys **▲/+** and **▼/–** to select the proper transducer type, and then press **ENT** key.
7. Press key **▼/–** to enter M24 window, press **ENT** key to enter the option selection mode. Use keys **▲/+** and **▼/–** to select the proper transducer mounting method, and then press **ENT** key.
8. Press key **▼/–** to enter M25 window and get the transducer installation distance.
9. Press **MENU 2 6** to store the parameters setup.

7. Transducers Installation

7.1 Choose installation points

Proper installation point is a key for transducer installation. Following factors must be considered: Full filled pipeline, shaking, steady flow, scaling, temperature, pressure, EMI, instrument well.

>> Full filled pipeline

Following situations can be full filled of liquid:

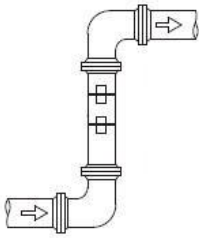

Vertical upward

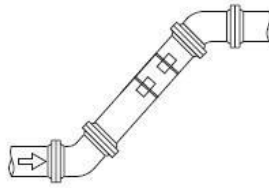

Obliquely upward

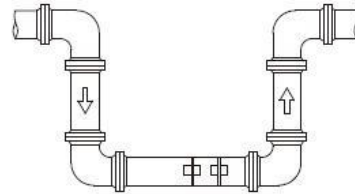

Lowest point

>> Shaking

There cannot be obvious shaking on the installation point, otherwise it needs to be tightened.

>> Steady flow

Steady flow is helpful for ensuring measurement accuracy.

Standard requests for steady flow are:

1. The pipe should be far away from pump outlet and half-open valve.
10D to upstream and 5D to downstream. (D means outer diameter)
2. 30D to pump outlet and half-open valve.

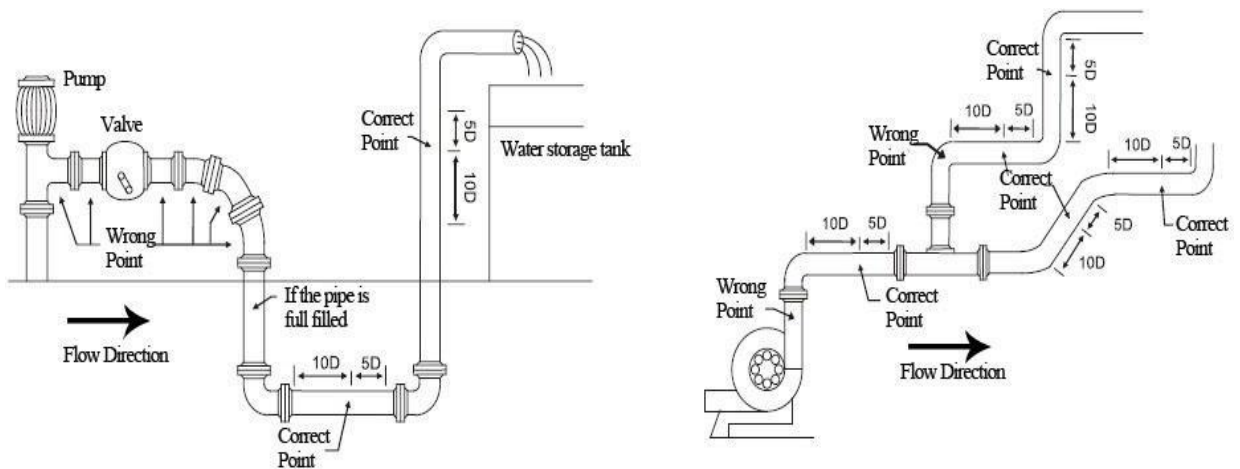

>> **Scaling**

The inside scaling would have bad effect on ultrasonic signal transmission, and would decrease the inner diameter as well. As a result, the measurement accuracy can not be guaranteed. Please try to avoid choosing the installation point with inside scaling.

>> **Temperature**

The liquid temperature on installation point should be in the working range of transducers. Please try to choose the point with lower temperature. Avoid to choose points like the outlet of boiler water and heat exchanger. Return water pipe would be better.

Temperature range of standard clamp on and insertion transducers: -30 ~ 90°C

Temperature range of high temperature clamp on and insertion transducers: -30 ~ 160°C

>> **Pressure**

The maximum pressure for standard insertion and inline transducer is **1.6MPa**

Out of this range need customized.

>> **EMI (electromagnetic interference)**

The ultrasonic flow meter, transducer and signal cable can be easily interfered by interference sources such as frequency changer, radio station, microwave station, GSM base station and high-tension cable. Please try to avoid these interference sources when choosing installation points.

The shield layer of flow meter, transducer and signal cable should be connected to earth.

Better to use isolated power supply. Do not use the same power supply with the frequency converter.

>> **Instrument well**

When measuring underground pipes or need to protect the measuring points, an instrument well is required. To ensure the enough installation space, the sizes of instrument well should meet the following requirements.

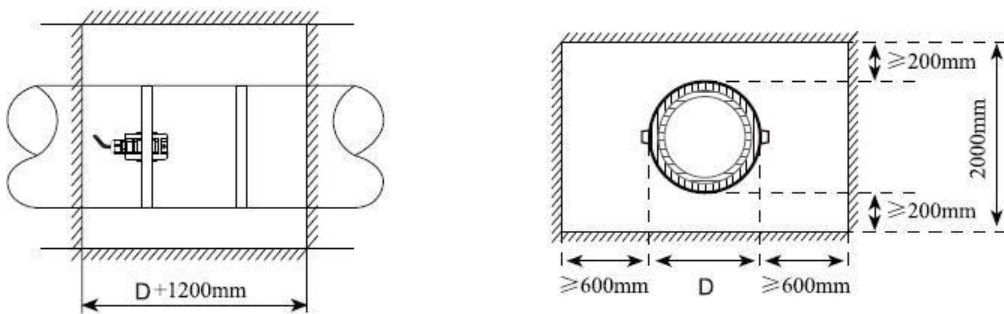

D means the pipe diameter

7.2 Clamp on transducer Installation

 Before installation, please verify the parameters of pipeline and liquid. To ensure the installation accuracy.

1) Installation procedure

Select an installation method → Input the measuring parameters → Clean pipe surface → Install transducers → Check the installation

2) Select an installation method

There are two different methods for clamp on transducers: V method and Z method.

>> V method

V method should be priority selected for pipe sizes DN25 - DN200. Let the pair of transducers horizontal alignment, the central line in parallel with the pipeline axis.

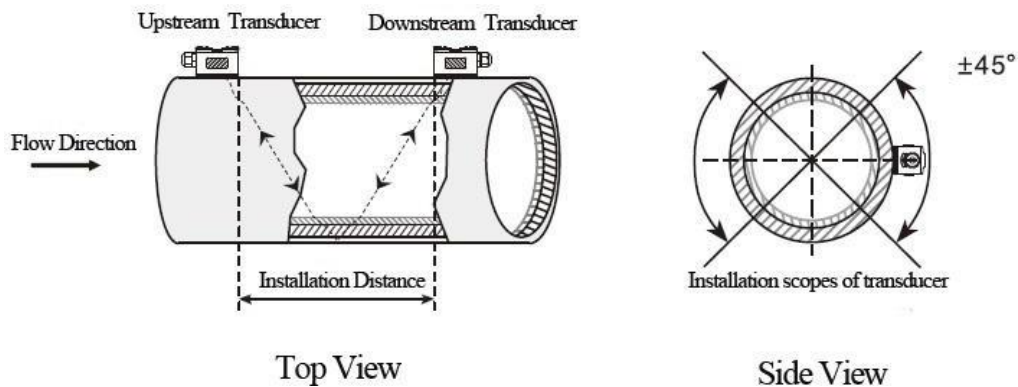

>> Z method

Z method should be priority selected for pipe sizes DN200 - DN6000. Also can be used when V method doesn't work well. Make sure the vertical distance of two transducers equals to the installation distance, and the two transducers are on the same axis surface.

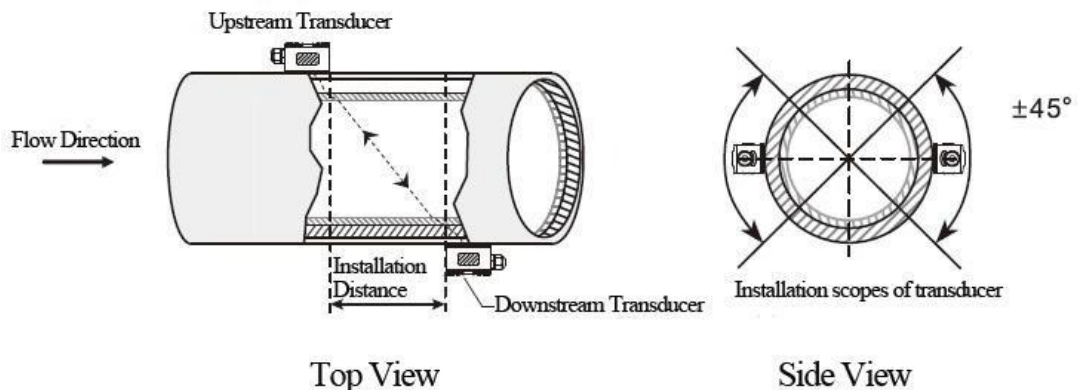

3) Positioning installation points

>> V method

The line between two transducers is parallel to pipe axis, and equal to the distance shown in the converter. As shown, A, B are the two installation points.

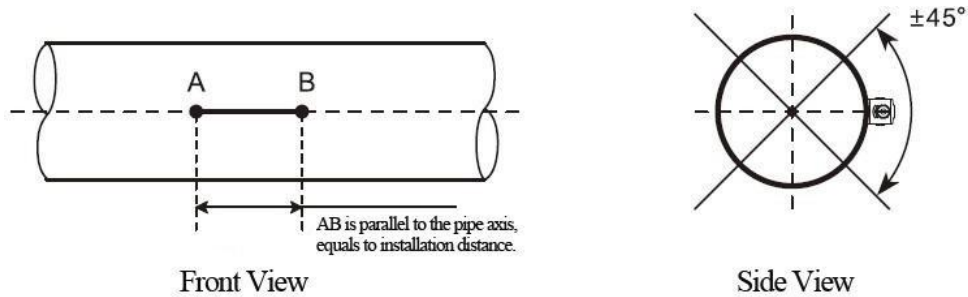

>> Z method

- ① Firstly according to the installation distance shown in converter, positioning two points A, C on the same side of pipeline. AC is parallel to pipe axis.
- ② Perpendicular to the pipe axis, opposite to point C, get Point B.
- ③ Check. Measure the length between A and B from both sides of the pipe, get AB_1 and AB_2 . If $AB_1 = AB_2$, then B is the correct point. If not, need to positioning point B and C again. As shown, A, B are the two installation points.

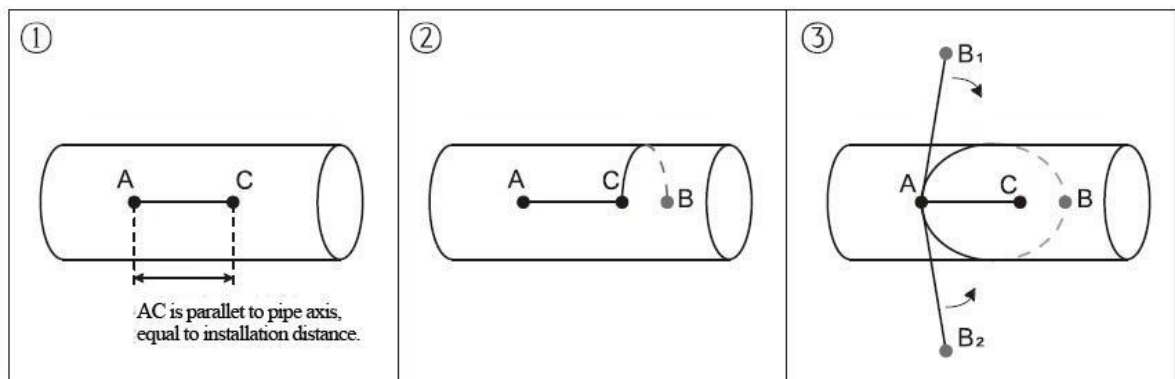

4) Clean the surface of installation points

Paint, rust and anti-corrosive coating on installation points need to be cleaned. It's good to use a polishing machine to get the metal luster.

As shown below:

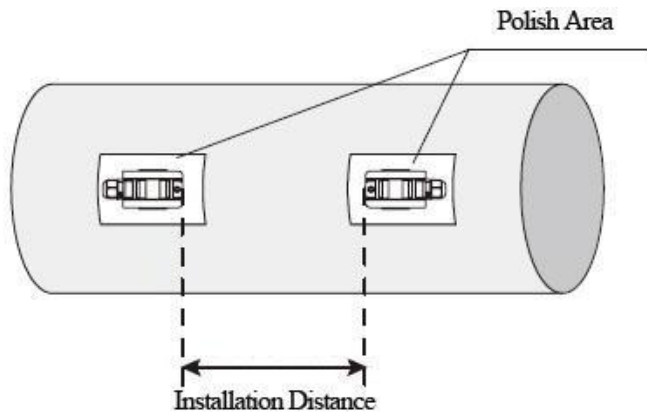

5) Install transducers

After transducer wiring and sealing, please evenly smear 2-3mm couplant on the transducer emitting surface. Then put the transducers on the installation points, fixed with steel belt or steel rope.

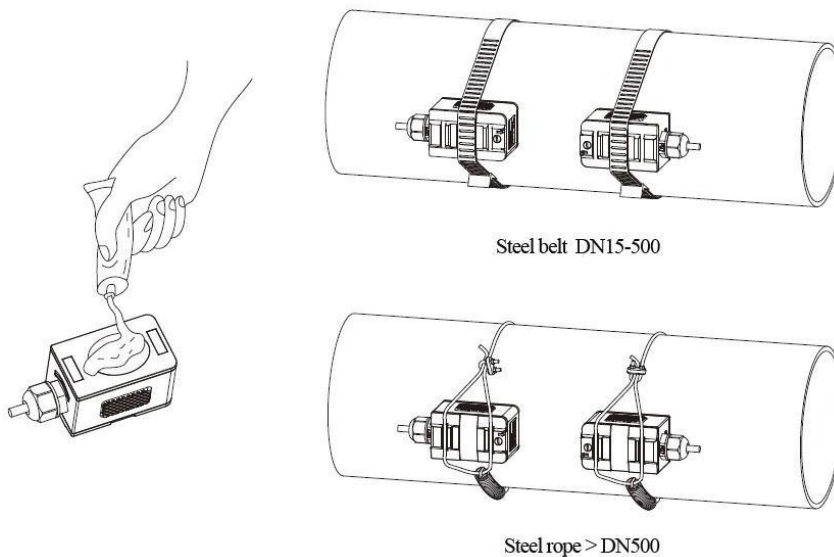

6) Check Installation

Please see details in Chapter 7.5

7.3 Insertion type transducer installation

 Before installation, please verify the parameters of pipeline and liquid. To ensure the installation accuracy.

1) Installation procedure

Select an installation method → Input the measuring parameters → Positioning installation points → Fix ball valve base → Open hole under pressure → Install transducers → Check the installation

2) Select installation method and positioning installation points

Insertion type transducers are suitable for pipe sizes > 50mm.

Two different installation methods: V method and Z method. Generally use Z method, only use V method for lack of space.

>> V method

V method can be used for DN50mm - 300mm. Let the pair of transducers horizontal alignment, the central line in parallel with the pipeline axis, and the transmit direction must be opposite.

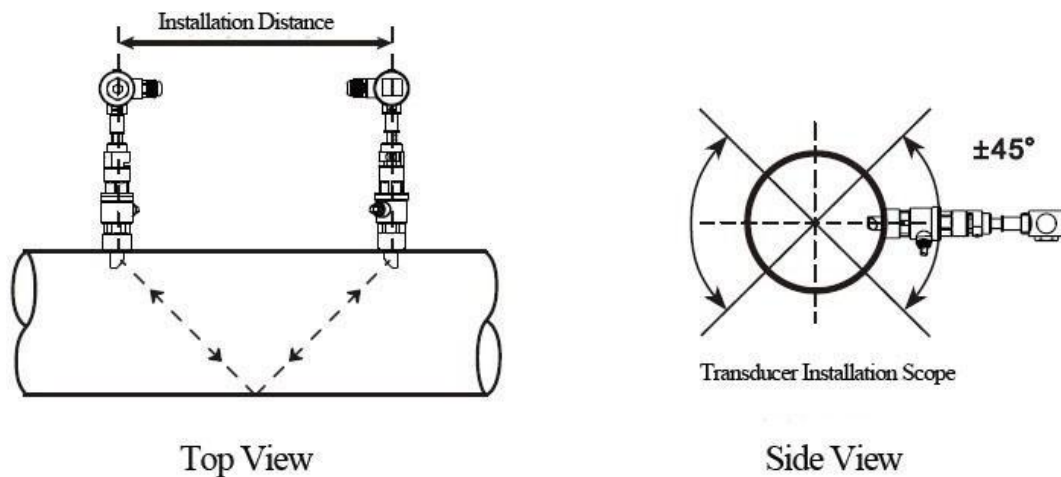

>> Z method

Z method can be used for all pipes > DN50mm. Make sure the vertical distance of two transducers equals to the installation distance, and the two transducers are on the same axis surface. The transmit direction must be opposite.

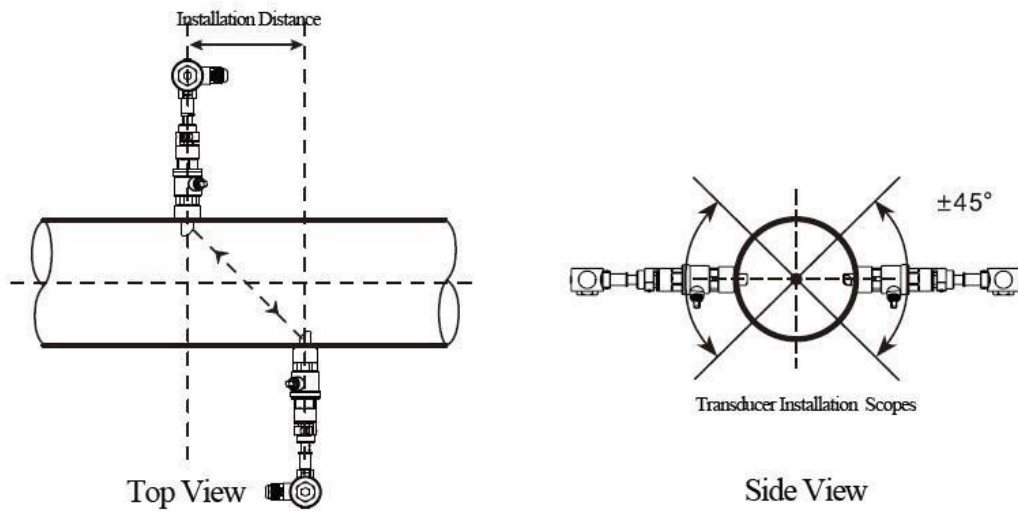

>> Parallel insertion

If there is insufficient installation space or the transducers can be only installed on the top of pipeline, parallel insertion transducer will be a good choice. (Pipe size ≥ 300)

Positioning of parallel insertion transducer need to meet the 3 factors as follow:

- Installation distance = Vertical distance of two transducers along the pipe axis direction
- Make sure two transducers are in the same horizontal line, Insertion depth = $\frac{1}{3}$ inner diameter
- Users can set the distance between transducers by themselves. Recommend 300~500mm

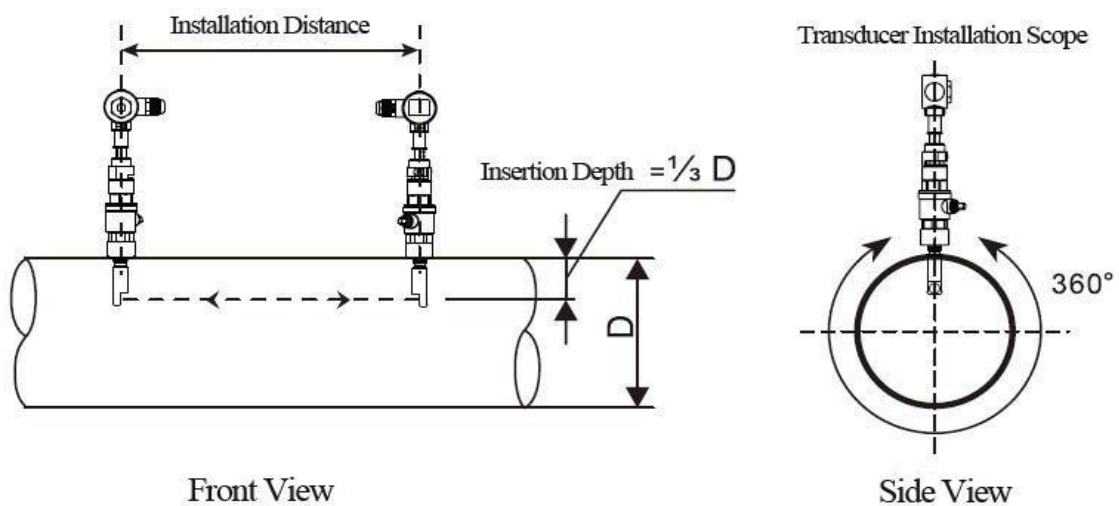

3) Positioning installation points

>> V method

The line between two transducers is parallel to pipe axis, and equal to the distance shown in the converter. As shown, A, B are the two installation points.

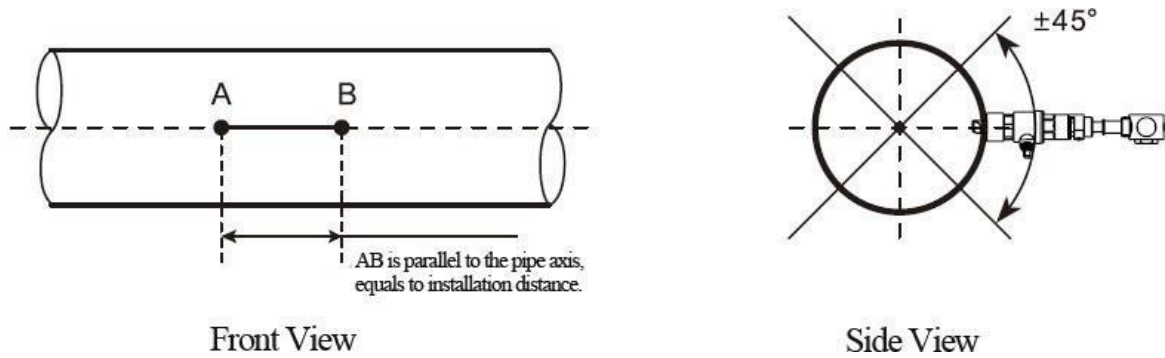

>> Z method

- ① Firstly according to the installation distance shown in converter, positioning two points A, C on the same side of pipeline. AC is parallel to pipe axis.
- ② Perpendicular to the pipe axis, opposite to point C, get Point B.
- ③ Check. Measure the length between A and B from both sides of the pipe, get AB_1 and AB_2 . If $AB_1 = AB_2$, then B is the correct point. If not, need to positioning point B and C again. As shown, A, B are the two installation points.

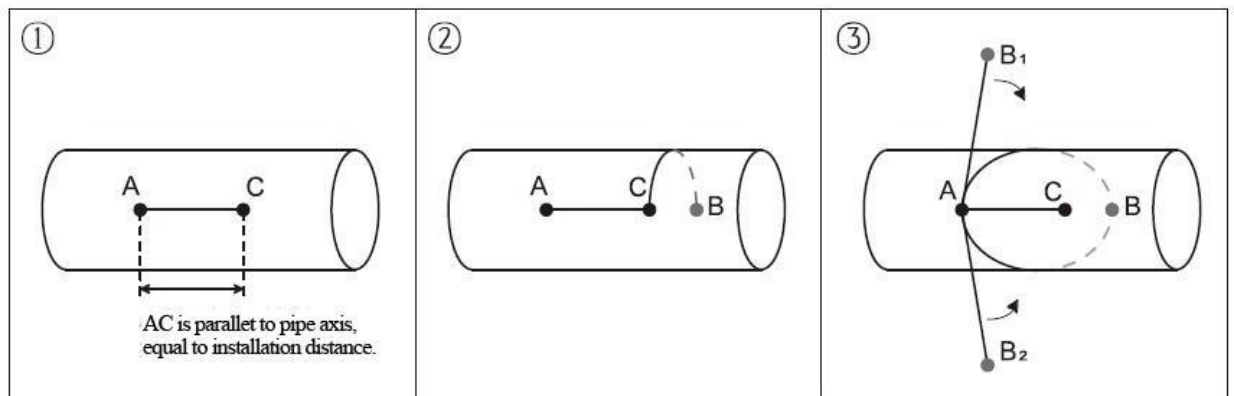

4) Fix ball valve base

>> Welding Fix

For carbon steel pipes, the ball valve base can be welded directly. Make sure that the central point of ball valve base is overlapped with the transducer installation point.

Matters need attention:

- Please take the PTFE sealing gasket out from the base before welding.
- Please clean the pipe surface around welding point before welding. Pay attention that there should not be any air hole during welding, which can avoid leaking. Welding strength must be ensured.
- Do not sputter welding slag on the base thread.
- Non-deformation of base during welding.

After welding, tighten ball valve into the base.

>> Pipe hoop Fix

For pipes can't be welded directly like cast iron pipe, cement pipe, copper pipe and composite pipe, customized pipe hoop is recommended.

The hoop center should be overlapped with the transducer installation point. Please compress the sealing gasket tightly to avoid leaking.

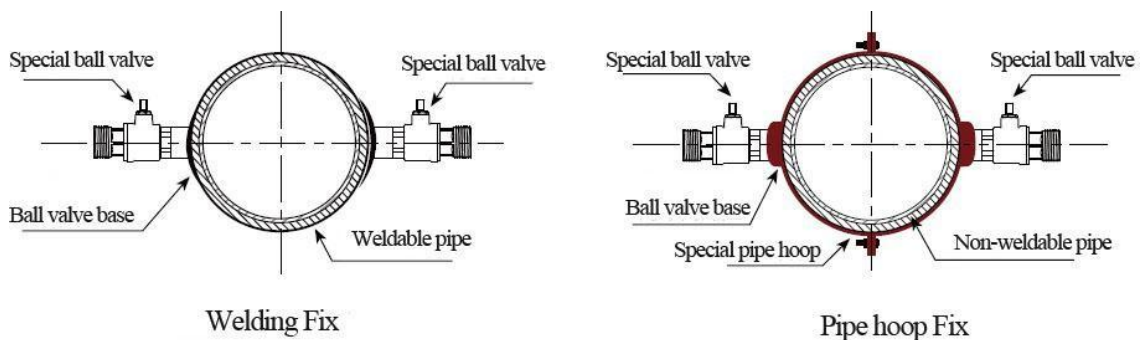

5) Open hole

After finishing the installation of ball valve and base, insert the open-hole tool into ball valve and lock it. Then open the ball valve, start drilling, from slow to fast. Close ball valve after drilling.

See more details in the video of insertion transducer installation.

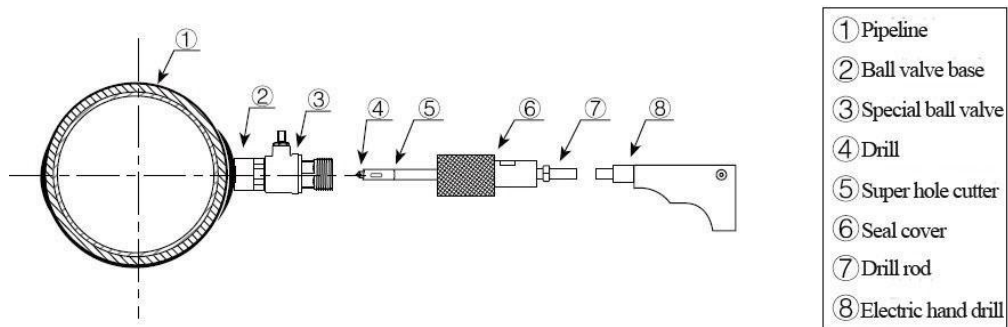

6) Install transducer and adjustment

Adjust the proper insertion depth and transmit direction to get good ultrasound signal.

>> Insertion depth adjustment

Adjust the depth scale according to pipe wall thickness, and completely push in the transducer rod.

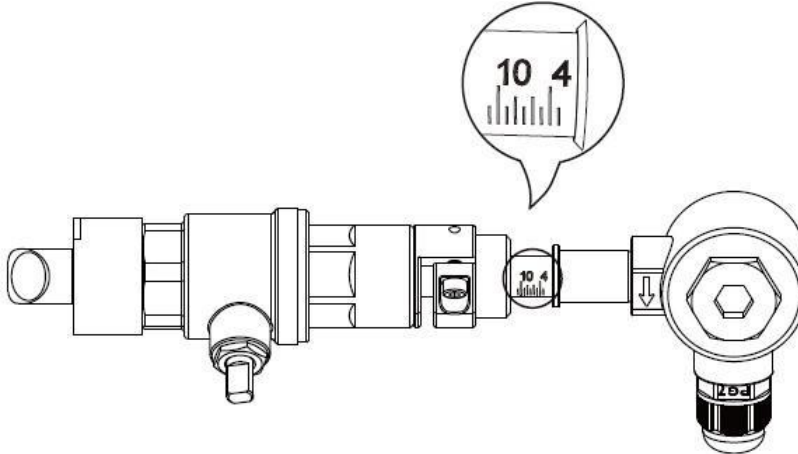

>> Transmit direction

There is a indicating arrow on the transducer junction box, the arrow direction on two transducers should be opposite “ $\rightarrow \leftarrow$ ” and parallel to the pipe axis.

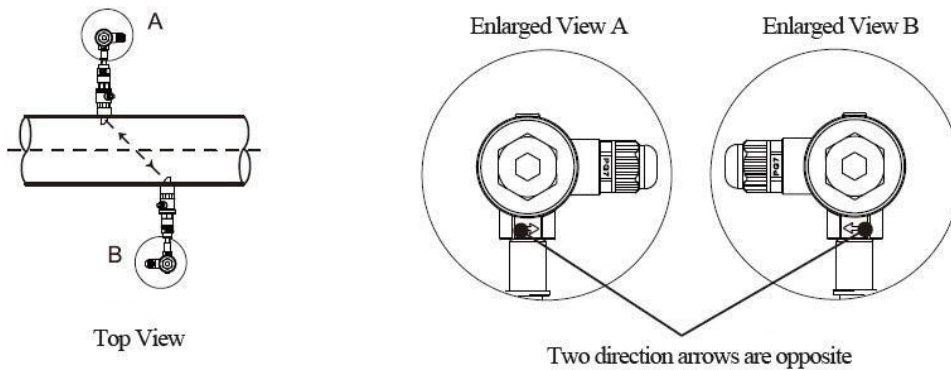

>>Operation steps

- Tighten the locknut into ball valve, adjust the insertion depth scale.
- Open ball valve, completely push in the upstream transducer rod. Adjust the transmit direction parallel with pipe axis, and point to the installation point of downstream transducer. Lock it after adjustment.
- Install downstream transducer in the same way. Adjust the transmit direction to get the best signal strength and watching Menu91, if the value is between 97% ~ 103%, the installation is correct. If not, need to re-adjust the insertion depth and transmit direction until meet the requirement.





7) Check installation

Please see details in Chapter 7.5

7.4 In-line type transducer installation

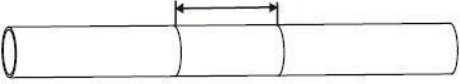
After choosing the installation point, install the transducer in the pipeline with companion flanges. Then connect the transducer to converter with special signal cable. Installation is complete.

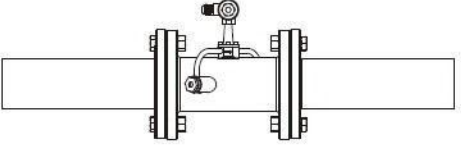
1) Installation method

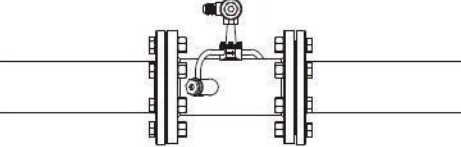
<p>① Confirm installation size</p> <p>Length of transducer L + 2×thickness of seal gasket + 10mm</p> 	<p>② Cutting pipeline</p> 
<p>③ Equip companion flanges</p> 	<p>④ Positioning the flanges</p>  <p>Twist 3 screws and averagely positioning the flanges. Fixing with spot welding.</p>
<p>⑤ Welding the flanges</p>  <p>Remove the inline transducer and full-length welding flanges.</p>	<p>⑥ As the flanges cooled, put in the seal gasket and tighten the screws. Then connect to converter with signal cable</p> 

2) Check installation

Please see details in Chapter 7.5

7.5 Check Installation

The flow meter includes the detection ability. M90 is used for checking signal strength and quality. M91 is used for checking the ratio of measured and theoretical transmission time (transmission time ratio).

1) Check signal strength and quality

M90 is used for checking the signal strength and signal quality(Q value) of upstream and downstream transducers.

Signal strength is represented by numbers 00.0 ~ 99.9, 00.0 means no signal and 99.0 means maximum signal. Generally, the flow meter can work properly when signal strength is > 60.0

Signal quality (Q value) is represented by numbers 00 ~ 99. 00 means signal is worst and 99 means signal is best. The flow meter can work properly when $Q > 60$.

During the installation, please adjust the transducer to make the signal strength and signal quality the larger the better. This will ensure the flow meter long term stable operation and lead to accurate measurement.

Signal strength and Q value	Installation Judgement
< 60	Can not work
60~75	Bad
75~80	Good
>80	Excellent

2) Check transmission time ratio

M91 is used for displaying transmission time ratio. It is a percentage ratio between theoretical transmission time and measured transmission time. It shows the relation between setting parameters and actual transducer installation distance. This ratio should be between 97% ~ 103%. If not in the range of 97%~103%, it means that the parameters and transducer installation distance are inconsistent. Please check separately.

8. Finish Installation

- 1) Commonly used menus. M00 or M02 is for meter reading. M30~M33 is for unit selection. M40 is for selecting damping factor, generally 5~10 sec. M60 is for correcting time and date. M26 is for curing parameters.
- 2) To avoid signal reduction and improve anti-jamming ability, it is better to use the customized signal cable from flow meter manufacturer.
- 3) The length of cables between converter and transducer should be as short as possible, cannot exceed 200m.
- 4) The temperature and humidity of working environment should be in the range of technical specifications. Avoid direct sunlight on LCD.