

Ultrasonic Flowmeter and Analyzer

Model: P118i



Update Record	Revision	3.0.0
	Date	11.2015

Notice

Thank you for choosing the P118i Ultrasonic Flowmeter and Analyzer with ARM chip and low-voltage wide-pulse sending technology.

This instruction manual contains important information. Please read it carefully before operation the flowmeter thus avoiding damage to the flowmeter from improper use.

This instruction manual will advise how to use the flowmeter step-by-step manner, including product component description, installation, wiring and quick setup etc. to make it easier to operate.

A working knowledge of the menu settings will assist you in understanding the flowmeters' powerful and output function.

**Warning**

May cause injury.







**Attention**

May damage the flow meter.

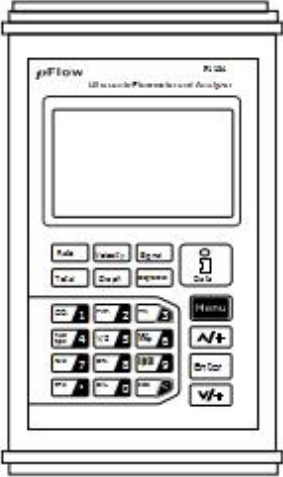
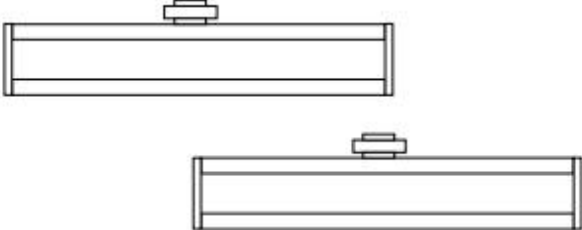
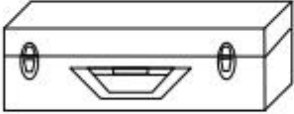
Some of the instructions may be different from the flowmeter and analyzer you have purchased. That depends on the configuration requirements. It also may be due to changes in product design, modification and upgrade .You will find the flowmeter display interface intuitive and easy to understand and it shall prevail when there is no indication of the instructions. Please refer to the version number and the appendix for more information.

Product Components

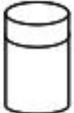
Inspection should be made before installing the flowmeter. Check to see if the spare parts are in accordance with the packing list. Make sure that there is no damage to the enclosure due to loose screw or wires or other damage that may have occurred during transportation. Any questions, please contact your representative as soon as possible.

Transmitter	Transducer
	
Accessories	Documents
 <p>Carrying Case</p>  <p>Cable</p>  <p>Signal Cable</p>  <p>Software</p>  <p>Pipe Straps</p>  <p>Coupling Compound</p>  <p>Charger</p>	 <ol style="list-style-type: none"> 1. Instruction 2. Packing List 3. Certified Factory Calibration

Content

1. Transmitter Installation and Connection	6
1.1 Power Supply Connections	6
1.1.1 Type of Power Supply	6
1.1.2 Wiring	6
1.1.3 4-20mA Wiring	7
1.2 Powering On	7
1.3 Keypad Functions	7
1.4 Keypad Operation	8
1.5 Flowmeter Menu Descriptions	9
2. The Quick Setup Description	10
2.1 Double Function Keys Menu Description	10
2.2 For example	14
2.3 Measurement Site Selection	16
3. Transducer Installation	18
3.1 Installing the Transducer	18
3.1.1 Transducer Mounting Methods	18
3.1.2 V Method	18
3.1.3 Z Method	18
3.1.4 N Method (not commonly used)	19
3.2 Transducer Installation and Fixing	19
3.3 Transducer Mounting Inspection	19
3.3.1 Signal Strength	19
3.3.2 Signal Quality (Q value)	20
3.3.3 Total Time and Delta Time	20
3.3.4 Transit Time Ratio	20
3.3.5 Warnings	20
4. Operating Instructions	21
4.1 System Normal Identification	21
4.2 Low Flow Cutoff Value	21
4.3 Zero Settings	21
4.4 Scale Factor	21
4.5 4 ~ 20mA Current Loop Output	21
4.6 4-20mA Analog Output Calibration	22
4.7 TF Card Operation	22
4.7.1 Specifications	22
4.7.2 Reading the TF Data Offline	23
4.7.3 TF Card Storage Operation Guide	23

4.8 ESN.....	24
5. Window Display Explanations	25
5.1 Window Display Codes	25
5.2 Display Explanation.....	26
6. Error Diagnoses	44
6.1 Table 1. Error Codes and Solutions (during operation)	44
6.2 Frequently Asked Questions and Answers.....	44
7. Product Overview	46
7.1 Introduction	46
7.2 Features of Flowmeter	46
7.3 Theory of Operation.....	46
7.4 Applications	47
7.5 Specifications.....	47
8. Appendix 1 - Flow Application Data	48
8.1 Sound Velocity and Viscosity for Fluids Commonly Used.....	48
8.2 Sound Velocity for Various Materials Commonly Used	48
8.3 Sound Velocity In Water (1 atm) At Different Temperatures	49

Update Information:

1. Transmitter Installation and Connection

1.1 Power Supply Connections

1.1.1 Type of Power Supply

The factory offers one rechargeable 11.1V Lithium battery and matching battery charger.

1.1.2 Wiring

Open the hinged top cover of the electronics. The wiring ports of the P118i, from left to right, are as follows:

The upstream transducer connector, downstream transducer connector, the battery recharge port (charge the transmitter or connect to a standby power supply), and the 4~20mA output connector.

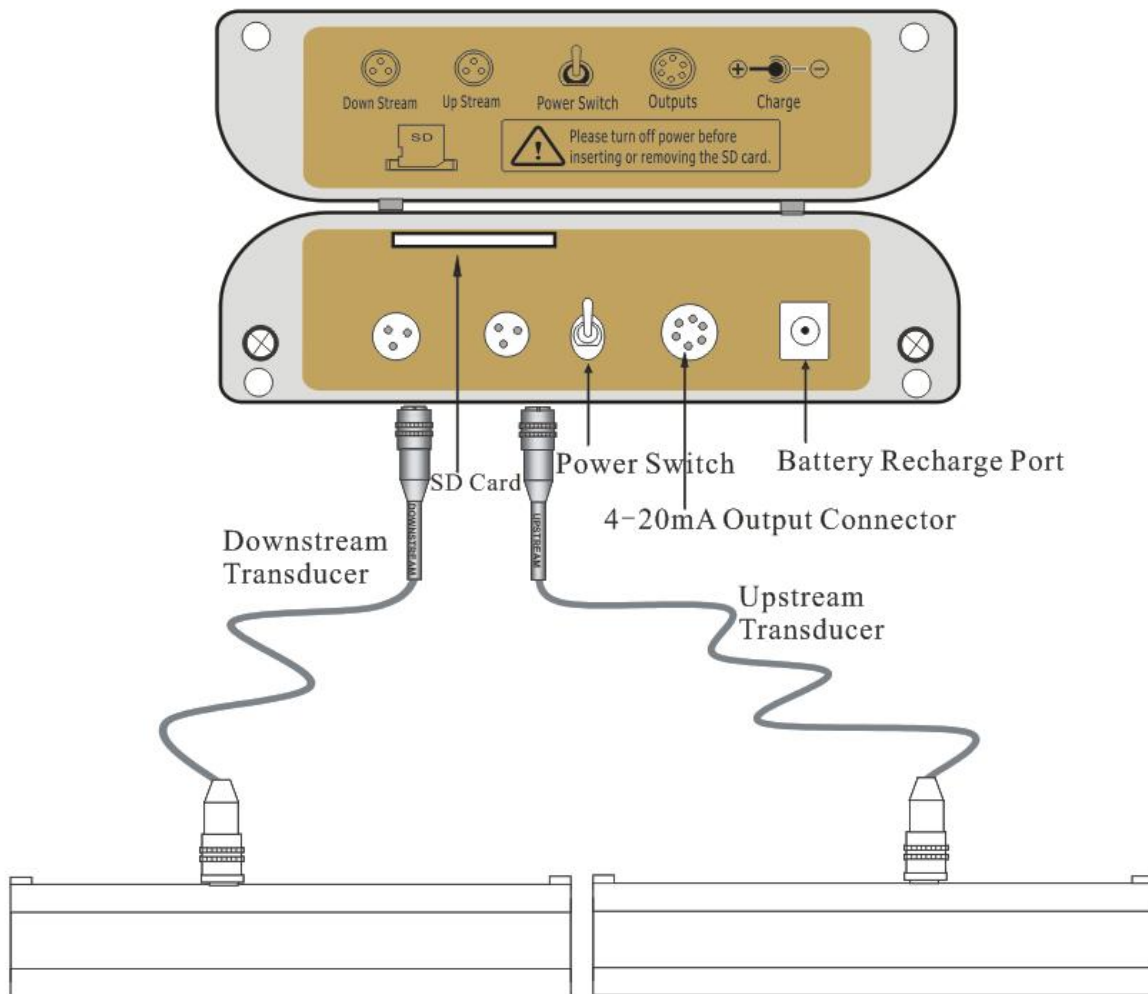

Warning

Wiring connections should be made when power is off.

1.1.3 4-20mA Wiring

4-20mA connection mode is as follows: the I + blue, I – black.

Welding surface view direction

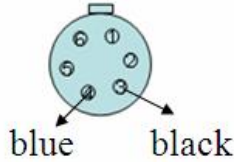

(Please do not use other extension interface)



1.2 Powering On

When the meter is powered on, it will start with the following screen, the Version Number Ver:1.01 and the Serial number S/N: 50004002 will be shown at the bottom right corner.



If it is the first time of use or an installation on a new site, the customer needs to input the new installation site parameters. Any parameters which are set by the user will be saved permanently until they are changed by the user.

When the user modifies the parameters or removes the transducers, the meter will recalculate automatically, and operate normally with the newly set parameters.

1.3 Keypad Functions

Follow these guidelines when using the flowmeter keypad:

and : Input numbers.

: Backspace or delete characters to the left.





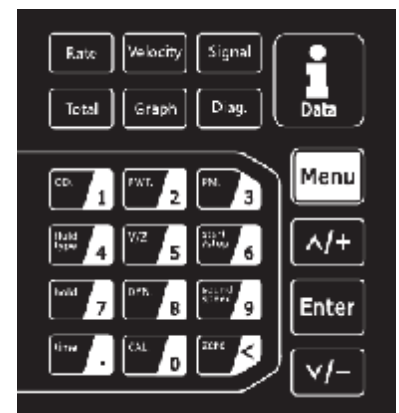

and : Return to the last Menu or open the next Menu. Acts as "+" and "-" are used to enter numbers.

: Select a Menu. Press this key first, input a two-digit Menu number and the selected Menu data will be displayed. For example, in order to input a pipe outside diameter, press where "11" is the window ID to display the pipe outside diameter.

: Enter / Confirm.





: Enter / Exit SD card storage interface.







      are shortcuts to the windows for Flow Rate, Velocity, Signal Quality, POS Totalizer, waveform, and Diagnosis.

1.4 Keypad Operation



The instrument setup and measurement displays are subdivided into more than 100 independent Menus. The operator can input parameters, modify settings or display measurement results by "visiting" a specific Menu. These Menus are arranged by 2-digit serial numbers from 00~99, then using +0, +1, etc. Each Menu ID code has a defined meaning. For example, Menu 11 indicates the pipe outside diameter, while Menu 25 indicates the mounting spacing between the transducers. Each Menu will be discussed later in this manual.

1. To visit a specific Menu, press the  key at any time except the SD Card Storage Interface, then input the 2-digit Menu ID code and that Menu will be displayed. For example, to input or check the pipe outside diameter, press the    keys for window ID code 11.





Another method to visit a particular Menu is to press the   and  keys to scroll through the Menus. For example, if the current Menu is 30, press  key to enter Menu 31, press the  button again to enter Menu 30.

The Menus are divided into three types: 1) Data Type, such as M11, M12; 2) Selection Type, such as M14; 3) Display Type, such as M00, M01.







Visit Data Type Menus to check specific parameters.

If parameter change is needed, just press  first, then input the values and press  to confirm.

Example 1: To enter a pipe outer diameter of 200mm, the procedure is as follows:

Press    to enter Menu11 (the numerical value displayed currently is the previous pipe outer diameter). Now press the  key. The symbol ">" and a flashing cursor is displayed on the screen. The new value can now be entered.

Visit Selection Type Menus to check the related options. If need to modify it, press  first to enter the revised selection when the symbol ">" is displayed on the screen; or input numbers directly to select the option when the symbol ">" and a flashing cursor are displayed.

Example 2: If the pipe material is "Carbon Steel", press    to enter Menu 14, then press  to modify the option. Then, select "0. Carbon Steel" from the drop-down Menu (you may cycle through the choices by pressing the  and  keys) and then press  to confirm the selection.

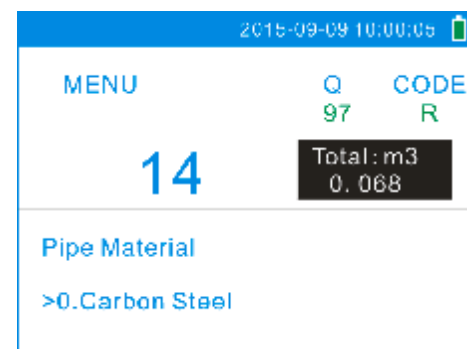
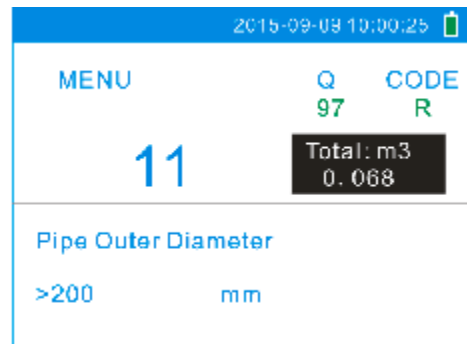

1.5 Flowmeter Menu Descriptions

These windows are assigned as follows:

- 00~09 Display Menus: Used to display flow rate, positive total, negative total, net total, velocity, date & time etc.
- 10~29 Setup Menus: Used to enter pipe outer diameter, pipe wall thickness, fluid type, transducer type, transducer mounting and spacing, etc.
- 30~38 Flow units selection and totalizer operating Menus: Used to select units of measurement. Other Menus set / reset the various totalizer modes.
- 40~45 Setup Menus: Zero Set Calibration menu, Scale Factor menu, etc.
- 46~81 Input and output setup Menus: current loop mode select, 4mA or 20mA output value, etc.
- 90~96 Diagnostics: signal strength quality (Menu 90), TOM/TOS*100 (Menu 91), sound velocity (Menu 92), total time and delta time of the measured signal (Menu 93), Reynolds number and K factor (Menu 94).
- 0 4~20mA correction Menu.



Attention

"Hidden" Menus are for hardware adjustment (retained by the manufacturer).

2. The Quick Setup Description

2.1 Double Function Keys Menu Description

Press  to display Flow Rate with large font.

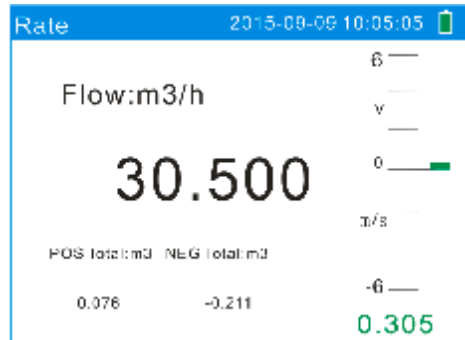

Press  to display Velocity with large font.



Press  to display Signal Quality with large font.







Press  to display POS Total with large font.







Press the  button to enter normal curve interface (Graph) model.



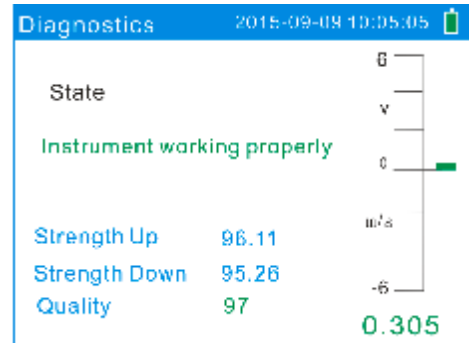



Press the  button loop switch (Graph) and dynamic (Dyn Mode) model; Press  or  key switch instantaneous flow/velocity curve; Press  to pause/continue to view the waveform curve.

Press  to display the Current State of the System.

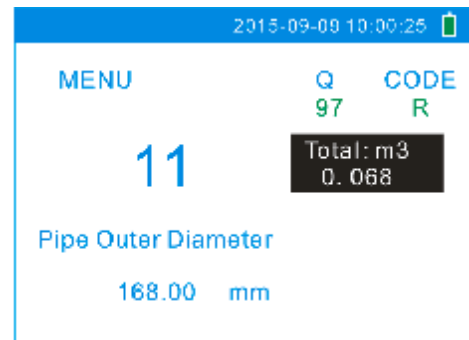

Press  to display Pipe Outside Diameter. The function is the same with   .





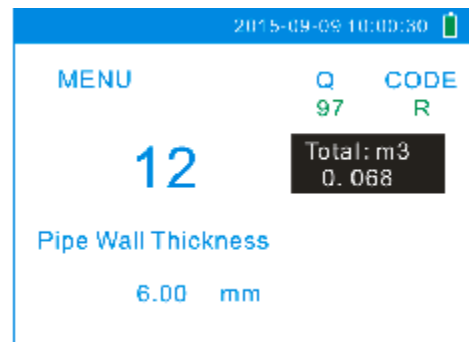

Press  to display Pipe Wall Thickness. The function is the same with   .

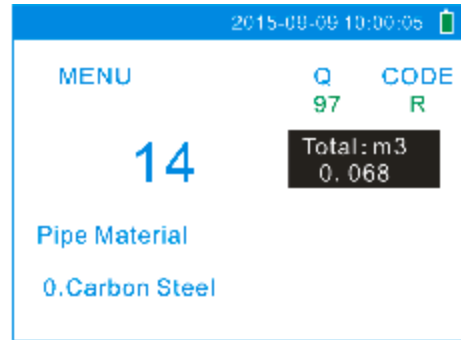





Press  to display Pipe Material. The function is the same with   .

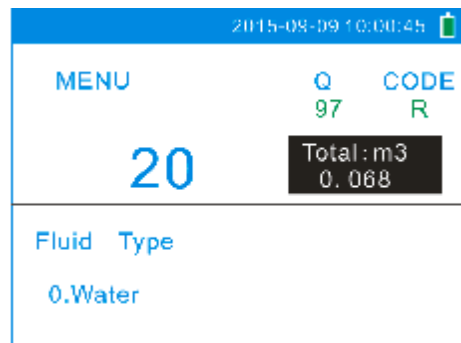

Press  to display Fluid Type. The function is the same with   .



Press  to display Transducer Mounting Methods. The function is the same with   .

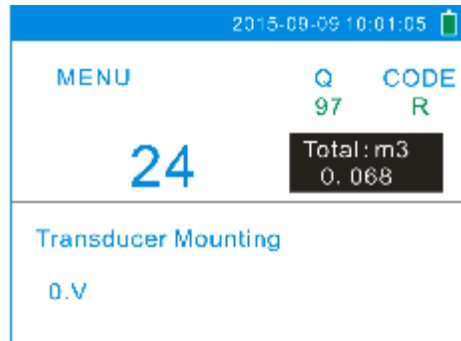





Press  to Start / Stop Manual Accumulation Total in turn.



Press  to Display / Hold Total in turn.



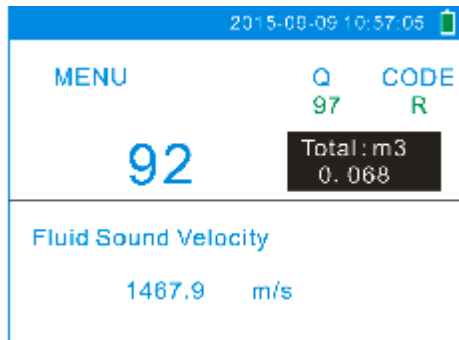

Press  to display Fluid Sound Velocity. The function is the same with   .

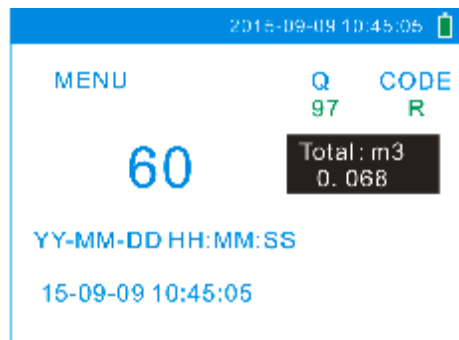

Press  to display Date and Time. The function is the same with   .



Press  to enter Manual Calibrate. After the flow velocity becomes steady, input standard totalizer to get the K factor. Then press  to complete the calibration.

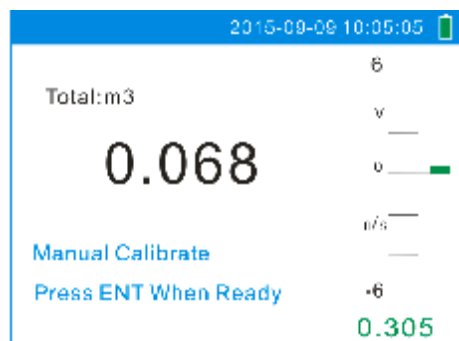



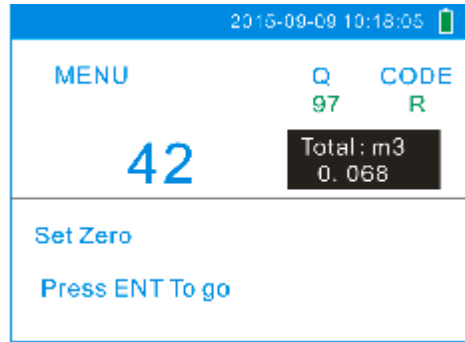

Press  to input the password 1234 to reset zero.



2.2 For example



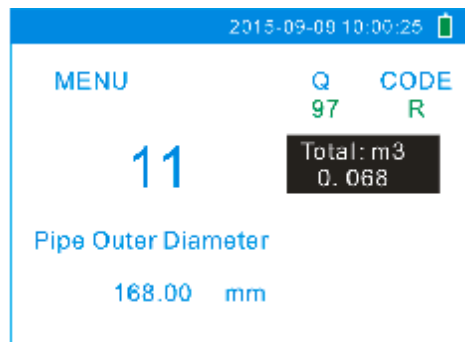

For Example: Let us assume you have a DN150 (6") pipe, measuring medium is water, Material is carbon steel with no liner. These parameters should be operated as follows:

Step 1. Pipe Outer Diameter

Press    keys to enter Menu 11, enter the Pipe Outside Diameter, then press the  key.







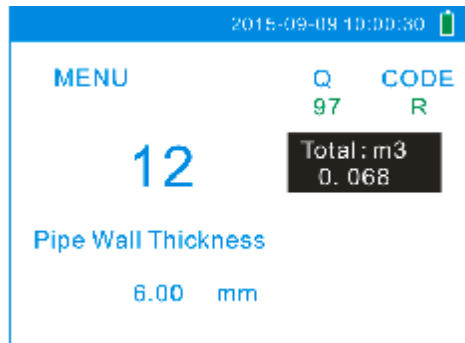

Step 2. Pipe Wall Thickness

Press the    key to enter Menu 12 the Pipe Wall Thickness, then press the  key.



Step 3. Pipe Material

Press the    key to enter Menu 14, press the  key, use the  or  key to select the pipe material from the drop-down Menu, then press the  key.

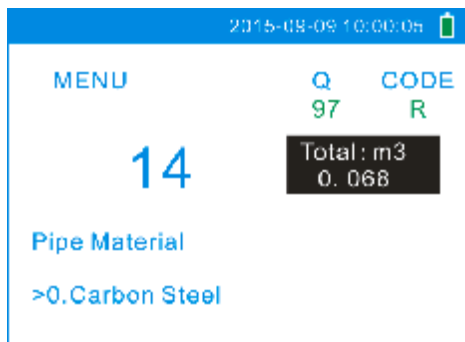

Step 4. Liner Material Parameters

(including thickness and sound velocity, if needed):

Press the **Menu** **1** **6** key to enter Menu 16, press the **Enter** key, use the **^/+** or **v/-** key to select liner material from the drop-down Menu, and then press the **Enter** key.

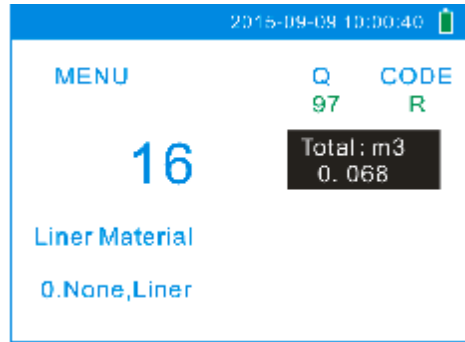

Step 5. Fluid Type

Press the **Menu** **2** **0** key to enter Menu 20, press the **Enter** key, use the **^/+** or **v/-** key to select fluid type from the drop-down Menu, then press the **Enter** key.

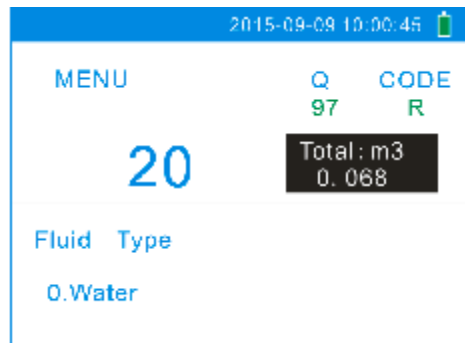

Step 6. Transducer Mounting

Press the **Menu** **2** **4** key to enter Menu 24, press the **Enter** key, use the **^/+** or **v/-** key to select transducer-mounting from the drop-down Menu, then press the **Enter** key. (Details on Chapter 3.1.1).

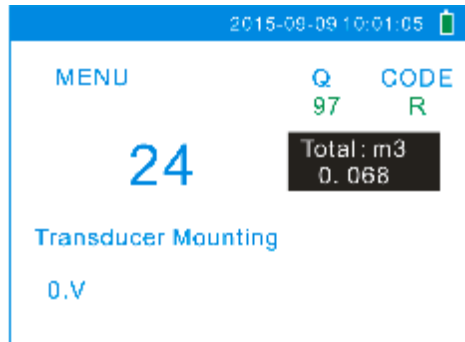

Step 7. Transducer Spacing

Press the **Menu** **2** **5** key to enter Menu 25, accurately install the transducer according to the displayed transducer mounting spacing and the selected mounting method. (Details on Chapter 2.3).

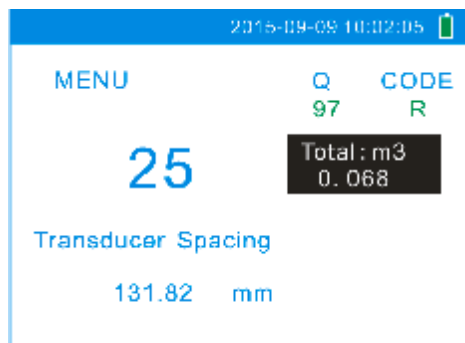

Step 8. Display Measurement Results

Press    to enter Menu 01 to display flow rate. (Subject to the real measurement.)

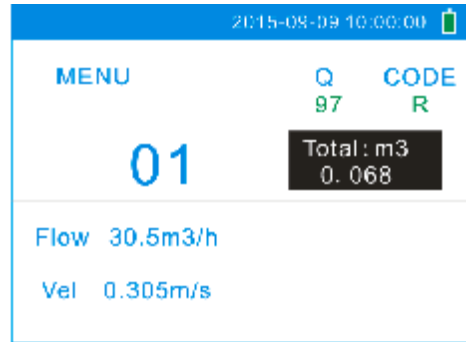

2.3 Measurement Site Selection

Compared with other kinds of flowmeters, Ultrasonic Flowmeter is the simplest one to install. Choose a proper measurement site, enter the pipe's parameters into the flowmeter. Install and fix the transducers on the pipe as instructed by the meter and start the measurement.

When selecting a measurement site, it is important to select an area where the fluid flow profile is fully developed to guarantee a highly accurate measurement. Use the following guidelines to select a proper installation site:

- l Choose a section of pipe that is always full of liquid, such as a vertical pipe with flow in the upward direction or a full horizontal pipe.
- l Ensure enough straight pipe length at least equal to the figure shown below for the upstream and downstream transducers installation.
- l On the horizontal pipe, the transducer should be mounted on the 3 o'clock and 9 o'clock position of the pipe section, avoid the 6 o'clock and 12 o'clock position, in order to avoid the signal attenuation caused by the sediment at the bottom, or air bubbles or cavitation.
- l Ensure that the pipe surface temperature at the measuring point is within the transducer temperature limits.
- l Consider the inside condition of the pipe carefully. If possible, select a section of pipe where the inside is free of excessive corrosion or scaling.
- l Choose a section of sound conducting pipe.

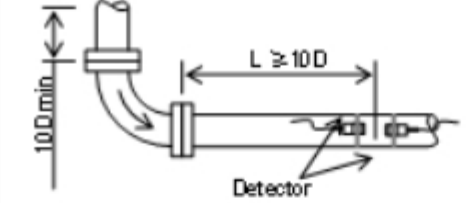
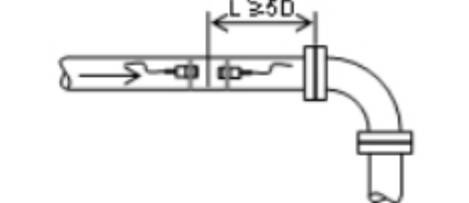
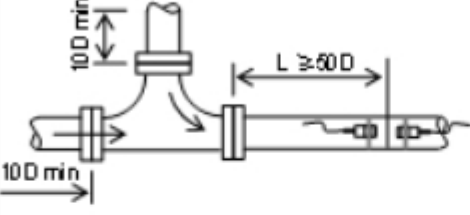
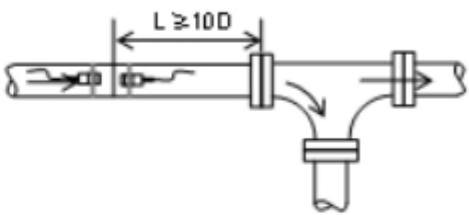
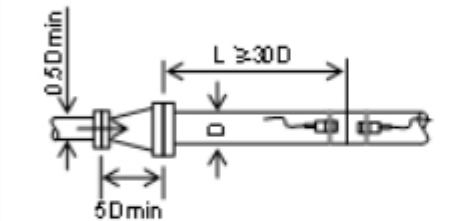
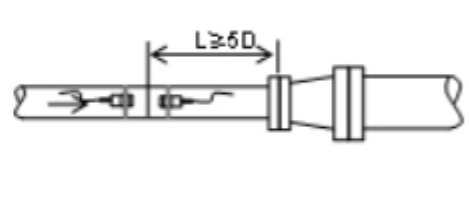
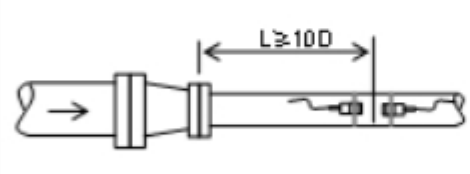
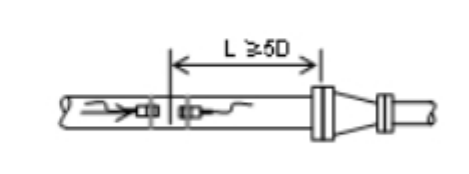
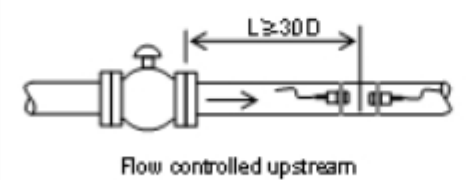
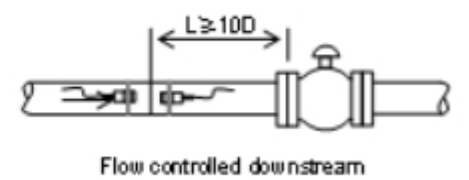
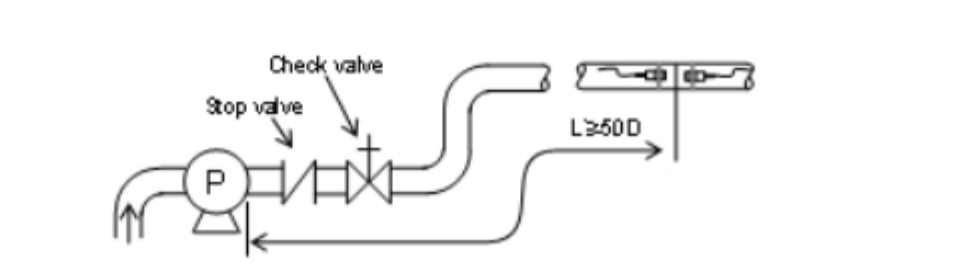
Name	Straight length of upstream piping	Straight length of downstream piping
90° bend		
Tee		
Diffuser		
Reduce		
Valve	 <p style="text-align: center;">Flow controlled upstream</p>	 <p style="text-align: center;">Flow controlled downstream</p>
Pump		

3. Transducer Installation

3.1 Installing the Transducer

Before installing the transducers, clean the pipe surface where the transducers are to be mounted. Remove any rust, scale or loose paint and make a smooth surface. Choose a section of sound conducting pipe for installing the transducers. Apply a wide band of sonic coupling compound down the center of the face of each transducer as well as on the pipe surface, ensure there are no air bubbles between the transducers and the pipe wall, and then attach the transducers to the pipe with the straps provided and tighten them securely.

Note:

1. The two transducers should be mounted at the pipe’s centerline on horizontal pipes. Make sure that the transducer mounting direction is parallel with the flow.
2. During the installation, there should be no air bubbles or particles between the transducer and the pipe wall. On horizontal pipes, the transducers should be mounted in the 3 o’clock and 9 o’clock positions of the pipe section in order to avoid any air bubbles inside the top portion of the pipe.
3. Refer to 2.15 for the Transducer Mounting Spacing.
4. If the transducers cannot be mounted horizontally symmetrically due to limitation of the local installation conditions, it may be necessary to mount the transducers at a location where there is a guaranteed full pipe condition (the pipe is always full of liquid).

3.1.1 Transducer Mounting Methods

Three transducer mounting methods are available. They are respectively: V method, Z method and N method. The V method is primarily used on small diameter pipes (DN100~300mm, 4"~12"). The Z method is used in applications where the V method cannot work due to poor signal or no signal detected. In addition, the Z method generally works better on larger diameter pipes (over DN300mm, 12") or cast iron pipes. The N method is an uncommonly used method. It is used on smaller diameter pipes (below DN50mm, 2").

3.1.2 V Method

The V method is considered as the standard method. It usually gives a more accurate reading and is used on pipe diameters ranging from 25mm to 400mm (1" ~ 16") approximately. Also, it is convenient to use, but still requires proper installation of the transducers, contact on the pipe at the pipe’s centerline and equal spacing on either side of the centerline.

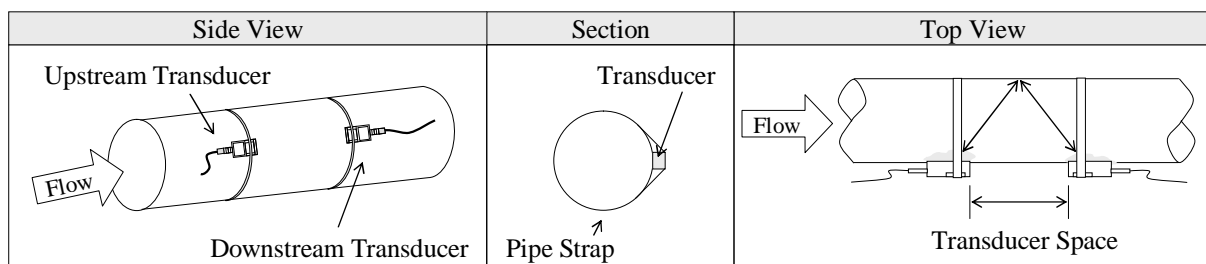

3.1.3 Z Method

The signal transmitted in a Z method installation has less attenuation than a signal transmitted with the V method when the pipes are too large, there are some suspended solid in the fluid, or the scaling and liner are too thick . This is because the Z method utilizes a directly transmitted (rather than reflected) signal which transverses the liquid only once. The Z method is able to measure on pipe diameters ranging from 100mm to 5000mm (4" to 200") approximately. Therefore, we recommend the Z method for pipe diameters over 300mm (12").

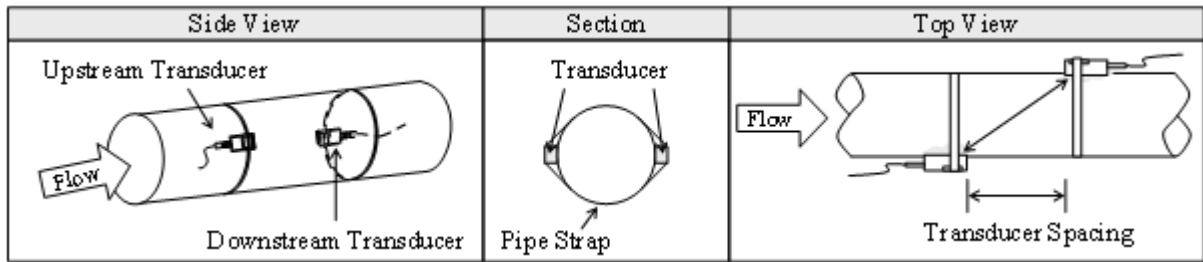

3.1.4 N Method (not commonly used)

With the N method, the sound waves traverse the fluid three times and bounce twice off the pipe walls. It is suitable for small pipe diameter measurement. The measurement accuracy can be improved by extending the transit distance with the N method (uncommonly used).

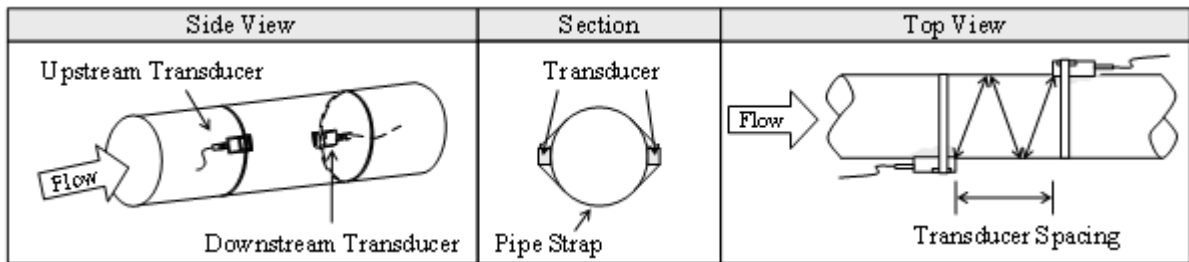

3.2 Transducer Installation and Fixing

Transducers can be installed onto the pipe with its magnetic racks. If you need to fasten them, then you can use the chains to make it firm. Show as below:

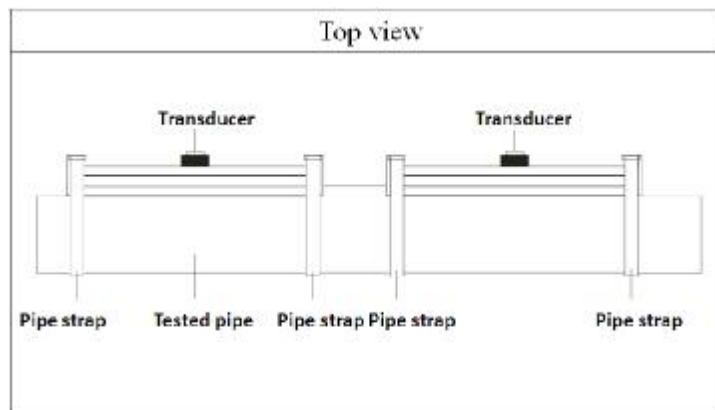

3.3 Transducer Mounting Inspection

Confirm the transducer is installed properly by checking the detected signal strength, total transit time, delta time as well as transit time ratio Key 9.

The "mounting" condition directly influences the flow value accuracy and system long-term operation reliability. In most instances it is only necessary apply a wide band of sonic coupling compound lengthwise on the face of the transducer and stick it to the outside pipe wall to get good measurement results. However, the following checks still need to be carried out in order to ensure a high reliability of the measurement and long-term operation of the instrument.

3.3.1 Signal Strength

Signal strength (displayed in Signal) indicates a detected strength of the signal both from upstream and downstream directions. The relevant signal strength is indicated by numbers from 00.0 ~ 99.9. 00.0 represents no signal detected while 99.9 represents maximum signal strength. Normally, the stronger the signal strength detected, the better the instrument reliably will be. It will also result in a more stable the measurement value.

Ensure enough sonic coupling compound has been applied. Adjust the transducer position during the installation to obtain the maximum signal strength.

Normal system operation requires signal strength over 65.0 from both upstream and downstream directions. If the signal strength detected is too low, the transducer installation position and the transducer mounting spacing should be re-adjusted and the pipe should be re-inspected. If necessary, change the mounting method to be Z method.

3.3.2 Signal Quality (Q value)

Q value is short for Signal Quality (displayed in Signal). It indicates the level of the signal detected. Q value is indicated by numbers from 00 ~ 99. 00 represents the minimum signal detected while 99 represent the maximum. Normally, the transducer position should be adjusted repeatedly and coupling compound application should be checked frequently to ensure the signal quality can be detected as strong as possible.

3.3.3 Total Time and Delta Time

"Total Time and Delta Time", which displays in Window M6.04, indicates the condition of the installation. The measurement calculations in the flowmeter are based upon these two parameters. Therefore, when "Delta Time" fluctuates widely, so does the velocity and flow. This means that the signal quality detected is poor. It may be the resulted of poor pipe-installation conditions, inadequate transducer installation or incorrect parameter input.

Generally, "Delta Time" fluctuation should be less than $\pm 20\%$. Only when the pipe diameter is too small or velocity is too low can the fluctuation be wider.

3.3.4 Transit Time Ratio

Transit Time Ratio indicates if the transducer mounting spacing is accurate. The normal transit time ratio should be 100 ± 3 if the installation is proper. Check it in Window M91.

Attention

If the transit time ratio is over 100 ± 3 , it is necessary to check:



If the parameters (pipe outside diameter, wall thickness, pipe material, liner, etc.) have been entered correctly,

If the transducer mounting spacing is in accordance with the display in Window M25,

If the transducer is mounted at the pipe's centerline on the same diameter,



If the scale is too thick or the pipe mounting is distorted in shape, etc.

3.3.5 Warnings

- (1) Pipe parameters entered must be accurate; otherwise the flowmeter will not work properly.
- (2) During the installation, apply enough coupling compounds to the transducer to ensure adequate contact with the pipe wall. While checking the signal strength and Q value, move the transducers slowly around the mounting site until the strongest signal and maximum Q value can be obtained. .
- (3) Check to be sure the mounting spacing is accordance with the display in Window M2.15 and the transducer is mounted at the pipe's centerline on the same diameter.
- (4) If the signal strength is always displayed as 0.00 there is no signal detected. Thus, it is necessary to check that the parameters (including all the pipe parameters) have been entered accurately. Check to be sure the transducer mounting method has been selected properly, the pipe is not worn-out, and the liner is not too thick. Make sure there is indeed fluid in the pipe or the transducer is not too close to a valve or elbow. Ascertain there is not too much air or solids in the fluid, etc. With the exception of these reasons, if there is still no signal detected, the measurement site has to be changed.
- (5) Keep the flowmeter away from the electromagnetic interference area to ensure its proper operation..
- (6) After completing the installation, power on the instrument and check the parameters and the result accordingly.

4. Operating Instructions

4.1 System Normal Identification

Press the    keys. If the letter "*R" displays on the screen, it indicates system normal.

If the letter "E" is displayed, it indicates that the current loop output is over ranged by 120%. This refers to the settings in Menu 57. Enter a larger value in Menu 57, and the letter "E" will disappear. It can be ignored if no current loop output is used.

If the letter "G" is displayed, it indicates that system is adjusting the signal gain prior to the measurement. Also, it means system normal. Only in such a condition for a long time, can the instrument be proved to be abnormal.

Letter "I" indicates no signal is being detected. Check to see if the transducer wiring connections are correct, the transducers are securely installed, etc.

For further information, please refer to "Error Diagnosis".

4.2 Low Flow Cutoff Value

The data in M41 is Low Flow Cutoff Value. If the flow rate falls below the low flow cutoff value, the flow indication is deemed to be ZERO. This can prevent the flow meter accumulate the flow when the actual flow is "0" after a pump was shut down. Generally, 0.03m/s is recommended to enter as the low flow cutoff point.

The low flow cutoff value has no relation to the measurement results once the velocity is higher than the low flow cutoff value.

4.3 Zero Settings

When zero flow occurs an instrument may have a zero point which shows a measured value is not equal to "0". This value indicates "Zero Offset". For any measuring instrument, the smaller the "Zero Offset" is, the better the accuracy will be. If the zero set point is not at true zero flow, a measurement error will occur. The smaller the measurement flow is, the larger the measurement error caused by the zero Offset will be. Only when zero point reduced to an acceptable degree can the measuring error caused by the zero point can be ignored.

For an ultrasonic flowmeter, the measurement error caused by the zero point cannot be ignored under low flow conditions. It is necessary to perform a static zero set calibration to improve the low flow measurement accuracy.

Set Zero in Menu42, press , and then wait for the processing indication or displayed Complete..If setting Zero in flowing conditions, it may cause the flow to be displayed as "0". If so, it can be recovered via Menu 43.

4.4 Scale Factor

Scale factor refers to the ratio between "actual value" and "reading value". For example, when the measurement is 2.00, and it is indicated as 1.98 on the instrument, the scale factor reading is 2/1.98. This means that the best scale factor constant is 1. However, it is difficult to keep the scale factor as "1" on the instrument especially in batch productions. The difference is called "consistency".







During operation, there still exists possible difference in pipe parameters, etc. The "scale factor" may be necessary when used on different pipes. Thus, scale factor calibration is specially designed for calibrating the differences that result from application on different pipes. The scale factor entered must be one that results from actual flow calibration. The scale factor can be input in Window M45.

4.5 4 ~ 20mA Current Loop Output

With a current loop output exceeding an accuracy of 0.1%, the flowmeter is programmable and configurable with outputs such as 4 ~ 20mA selected in Menu 55. Please refer to Menu 55 in "Window Display Explanations" for more information.

In Window M56, enter a 4mA flow value. Enter the 20mA flow value in Window M57. For example, if the flow range in a specific pipe is 0 ~ 1000m³/h, enter 0 in Window M56 and 1000 in Window M57. If the flow ranges from -1000~0~2000m³/h, configure the 20~4~20mA output by selecting in Window M55 when flow direction is not an issue. Enter -1000 in Window M56 and 2000 in Window M57.

Calibrating and testing the current loop is performed in Window M58. Complete the steps as follows:

Press   5  8 , move  or  to display "4mA" "20mA", connect an ammeter to test the current loop output and calculate the difference and check whether the difference is within tolerance or not. Refer to Section 4.6 for Current Loop Verification.

Check the present current loop output in Window M59, the value will change along with the change of the flow.

4.6 4-20mA Analog Output Calibration







Attention

Each flowmeter has been strictly calibrated before leaving factory. It is unnecessary to carry out this step except when the current value (detected while calibrating the current loop) displayed in Window M58 is not identical with the actual output current value.

Calibrate the analog input required to expand the hardware debugging Menu as below procedures:

Press    0  to enter the password "115800" then press . This action will be inoperative after powering off.

Then press  to enter the Current Loop Verification Mode, press  to enter the 4mA verification status, use an accurate ammeter to measure the output current of the current loop, and move  or  to adjust the displayed values, wait for the ammeter current value to reach "4.00mA", then the 4mA verification is finished.

Press  to do the 20mA verification using the same procedure as for the 4mA verification.

The verification results will be automatically saved in the EEPROM and will not be affected when the instrument is powered off.

4.7 TF Card Operation

4.7.1 Specifications

Memory: 2 GB ((To prevail in kind)).

Note: The SD card is a consumable item and its models updates quickly. Thus the configuration is on the basis of the physical matter received.

Data collection interval: any interval settings from 1 to 60 seconds are OK according to the requirement. If the rate is set longer than 60 seconds the default will be 60 seconds; when it is set to be less than 1 second, it will default to 1 second.

Data content: date and time, flow rate, flow velocity, total flow, positive totalizer and negative totalizer.

Data collection time: user selectable from 1~9999 mins. If it is set longer than 9999 mins, it will default to 9999 mins.

Data storage format: 1=07-04-10,14:16:33
 2=+3.845778E+01 m³/h
 3=+1.451074E+00 m/s
 4=-0000010E+0 m³
 5=+0000002E+0 m³
 6=-0000012E+0 m³

File system format: FAT32

File type: plain text file(.TXT)

File capacity: maximum 512 pcs

File name format: mmddhhmm (yy - year, mm - month, dd - date)

Turn to Chapter 5.7.4 for details if want to change a file name.

When the capacity of the SD card is full, the new data will override the earliest files automatically (it will rollover).



Attention

Plug the SD memory card need to be done in the case of power cuts.

4.7.2 Reading the TF Data Offline

Remove the TF card from the flowmeter and insert into the TF card reader. Copy the data to the PC. Use "Converter.exe" software to convert the format when needed.

1. File converter (Click the "Offline" button and enter the Document Conversion Interface).

Press "Converter" button, convert the T card data format from ".TXT" to ".XLS", the interface is as follows:

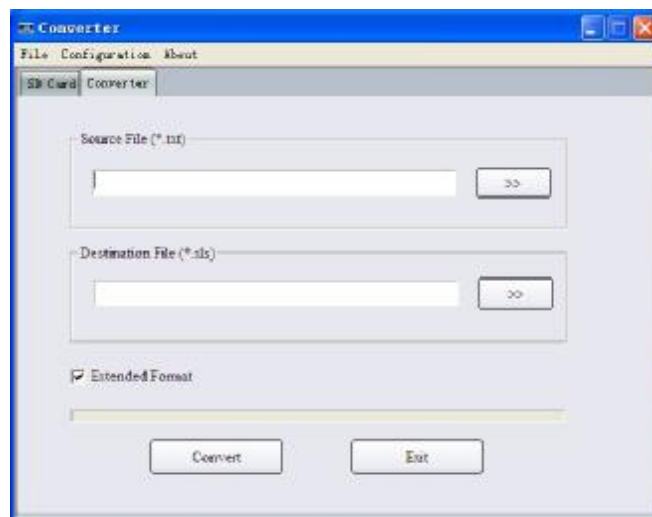

Select the file to be converted in "Source File (*.txt)", enter the directory path and the file name in "Destination File (*.xls)", then press "Convert". If "OK!" is displayed, the conversion is completed.

4.7.3 TF Card Storage Operation Guide

1. Insert the SD card, then press  button to enter the SD card storage setting interface.

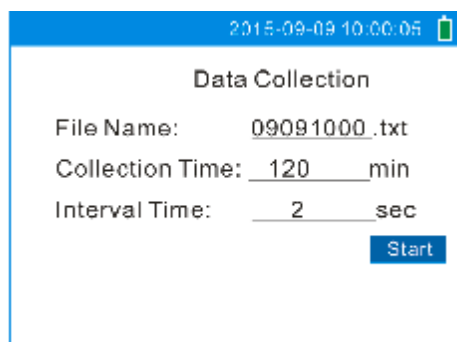

2. If you need to modify the file name, acquisition time or acquisition interval, enter the number to modify it directly, press **^/+** or **v/-** key choice, press **Enter** to modify, press **Enter** to the completed modification.



3. After modification or to use the default value, press **Enter** to store the data. The above picture shows the normal operation interface. (If it does not work normally, will be shown as the picture below.)

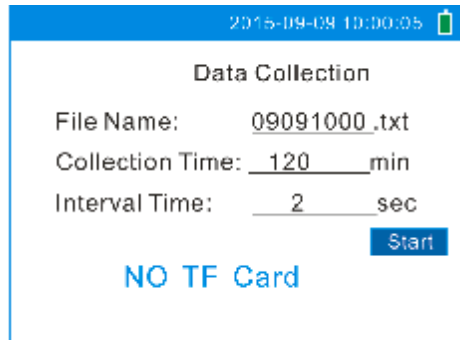

4. If need to stop store the data, choose "Stop", "Start"and press **Enter** to stop or start data storage. Then choose "OK"and press **Enter** to exit the SD Card storage.

4.8 ESN

We provide the Flowmeter and Analyzer with a unique electronic serial number to identify each Flowmeter for the convenience of the manufacturer and customers. The ESN is able to be viewed in Window M61.



Attention

Other Operating Refer to "5.2 Window Display Explanations".

5. Window Display Explanations

5.1 Window Display Codes

Flow Totalizer Display	
00	Flow Rate/Net Totalizer
01	Flow Rate/Velocity
02	Flow Rate/POS Totalizer
03	Flow Rate/NEG Totalizer
04	Date Time/Flow Rate
08	System Error Codes
09	Net Flow Today
Initial Parameter setup	
10	Pipe Outer Perimeter
11	Pipe Outer Diameter
12	Pipe Wall Thickness
13	Pipe Inner Diameter
14	Pipe Material
15	Pipe Sound Velocity
16	Liner Material
17	Liner Sound Velocity
18	Liner Thickness
20	Fluid Type
21	Fluid Sound Velocity
22	Fluid Viscosity
24	Transducer Mounting
25	Transducer Spacing
26	Parameter Setups
27	Cross-sectional Area

28	Holding with Poor Sig
29	Empty Pipe Setup
Flow Units Options	
30	Measurement Units
31	Flow Rate Units
32	Totalizer Units
33	Totalizer Multiplier
35	POS Totalizer
36	NEG Totalizer
37	Totalizer Reset
38	Manual Totalizer
Setup Options	
40	Damping
41	Low Flow Cutoff Velocity
42	Set Zero
43	Reset Zero
44	Manual Zero Point
45	Scale Factor
Input and output setup	
46	Network IDN
47	System Lock
48	Segmented Correction
49	Segment Factor
55	CL Mode Select
56	CL 4mA Output Value

57	CL 20mA Output Value
58	CL Checkup
59	CL Current Output
60	Date and Time
61	ESN
62	RS485 Setup
67	FO Frequency Range
68	Low FO Flow Rate
69	High FO Flow Rate
72	Working Timer
73	Alarm #1 Low Value
74	Alarm #1 High Value
77	Beeper Setup
Diagnoses	
90	Signal Strength and Quality
91	TOM/TOS*100
92	Fluid Sound Velocity
93	Total Time and Delta
94	Reynolds Number and Factor
96	Time Fixed Delay
97	Language Select
Appendix	
-0	Hardware Parameter Modification

NOTE: The factory maintains the final explanation for other menu features.

5.2 Display Explanation



Flow Rate / Net Totalizer

Display flow rate and net totalizer.

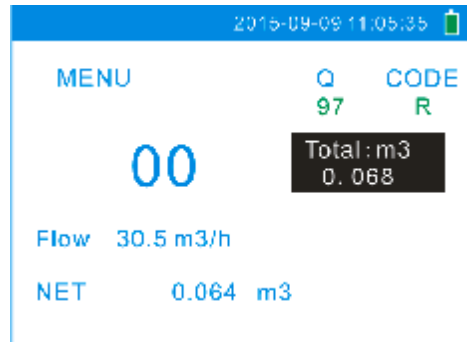

Flow Rate / Velocity

Display flow rate and velocity.

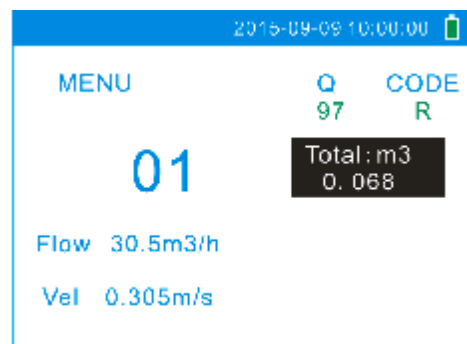

Flow Rate / Positive Totalizer

Display flow rate and positive totalizer.

Select the Flow Rate units in Window M31.

Select the positive Totalizer units in Window M32.

If the positive totalizer has been turned off, the positive totalizer value displayed is the total the total that existed prior to turning it off.

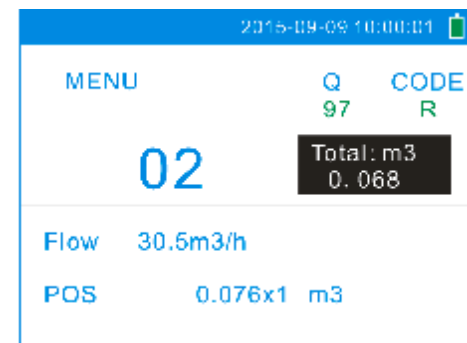

Flow Rate / Negative Totalizer

Display flow rate and negative totalizer.

Select the negative totalizer value in Window M32.

If the negative totalizer has been turned off (refer to M36), the value displayed is total the total that existed prior to turning it off.

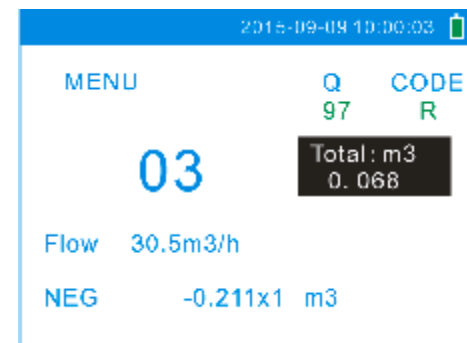



Current Time / Flow Rate

Display the current time and flow rate.

The time setting method is found in window M60.

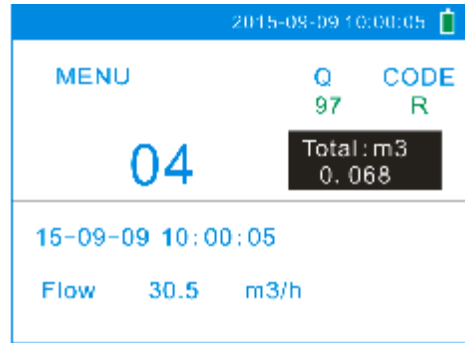

System Error Codes

Display the operating condition and the system error codes. More than one error code can occur at the same time.

The explanations of error codes and detailed resolution methods can be found in "Error Diagnosis".



Net Flow Today

Display net total flow today.

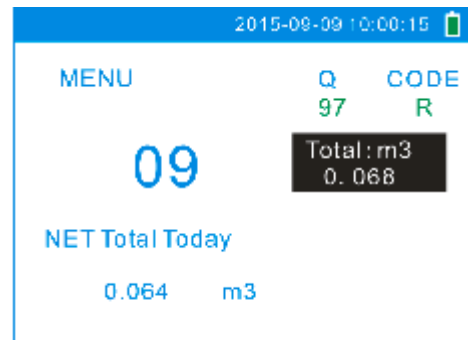

Pipe Outer Perimeter

Enter the pipe outer perimeter (circumference). If the pipe outer diameter is known, enter it in window M11.

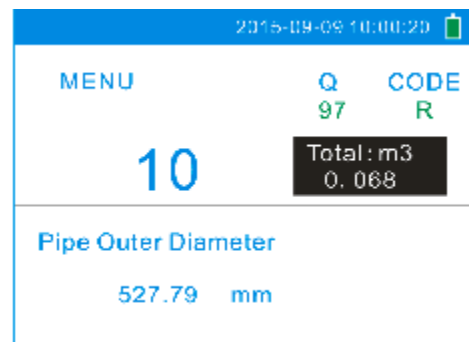



Pipe Outside Diameter

Enter the pipe outside diameter; the pipe outside diameter must range from 15mm to 6000mm.

Note:

Enter either the pipe outside diameter or pipe outer perimeter.

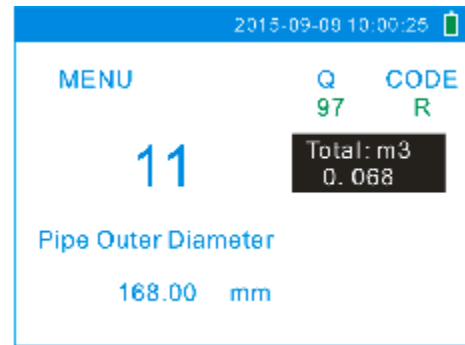

Pipe Wall Thickness

Enter the pipe wall thickness. If the pipe inside diameter is already known, skip this window and enter it in window M13.

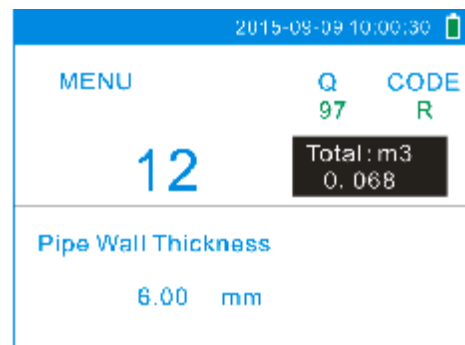

Pipe Inner Diameter



Enter the pipe inside diameter. If the pipe outside diameter and pipe wall thickness has been entered, press  to skip this window.

Note:

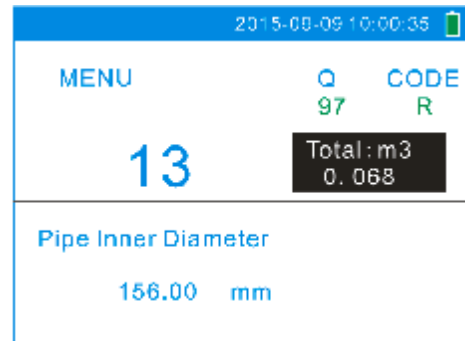
Enter either pipe wall thickness or pipe inside diameter.



Pipe Material

Enter pipe material. The following options are available (by ,  buttons or numerical keys):

- 0. Carbon Steel
- 1. Stainless Steel
- 2. Cast Iron

3. Ductile Iron
4. Copper
5. PVC
6. Aluminum
7. Asbestos
8. Fiber Glass-Epoxy
9. Other

Refer to item 9 "Other"; it is possible to enter other materials, which are not included in previous eight items. Once item 9 is selected, the relevant pipe sound velocity must be entered in Window M15. If sound velocity is not known, there are other ways to determine it on site.

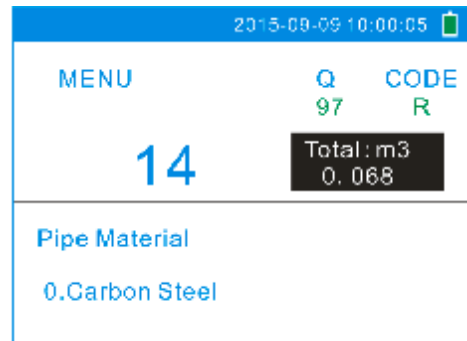

Pipe Sound Velocity

Enter pipe sound velocity. This function is only used when item 9 "Other" is selected in Window M14. At the same time, this window cannot be visited. It will be calculated automatically according to the existing parameters.

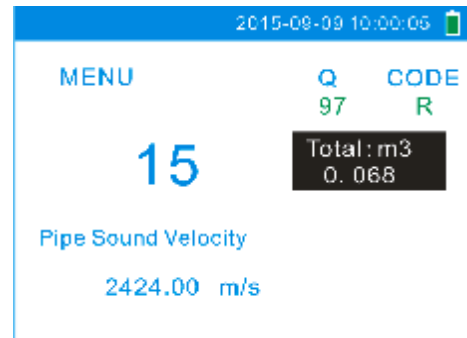

Select the Liner Material

The following options are available:

0. None ,No Liner
1. Tar Epoxy
2. Rubber
3. Mortar
4. Polypropylene
5. Polystyrol
6. Polystyrene
7. Polyester
8. Polyethylene
9. Ebonite
10. Teflon
11. Othe

Item 11 "Other" is available to enter other materials that are not included in previous ten items. Once the "Other" is selected, the relevant liner sound velocity must be entered in Window M17.

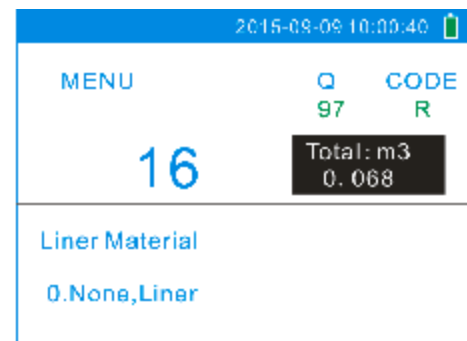



Liner Sound Velocity

Enter liner sound velocity. It only can be visited when item " Other" in Window M16 is selected.

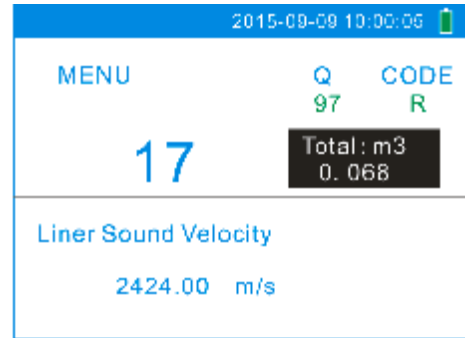

Liner Thickness

Enter liner thickness. It only can be visited when a definite liner is selected in Window M16.

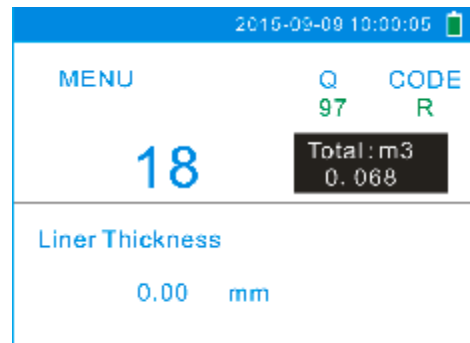

Select Fluid Type

The following options are available:

- 0. Water
- 1. Sea Water
- 2. Kerosene
- 3. Gasoline
- 4. Fuel Oil
- 5. Crude Oil
- 6. Propane (-45°C)
- 7. Butane (0°C)
- 8. Other
- 9. Diesel Oil
- 10. Castor Oil
- 11. Peanut Oil
- 12. Gasoline #90
- 13. Gasoline #93
- 14. Alcohol
- 15. Water (125°C)

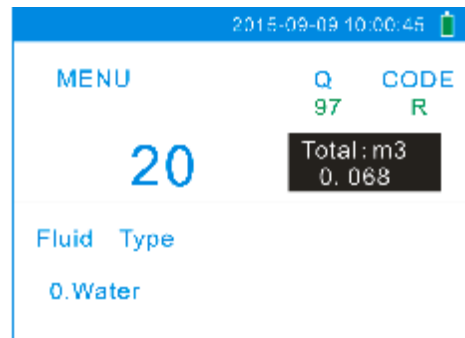



Fluid Sound Velocity

Enter the fluid sound velocity. It only can be used when item "Other" is selected in window M20, i.e. it is unnecessary to enter all the fluids listed in Window M20.

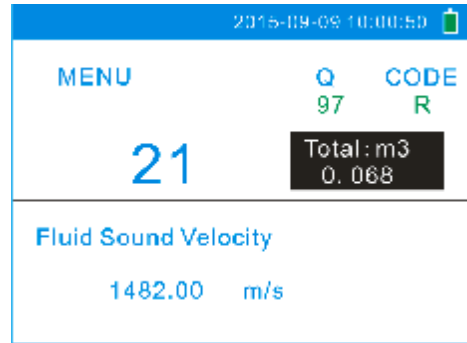

Fluid Viscosity

Enter fluid's kinematics viscosity. It only can be used when item "Other" is selected in Window M20, i.e. it is unnecessary to enter all the fluids that listed in Window M20.

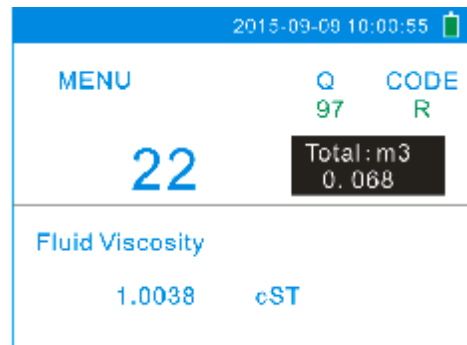

Transducer Mounting

Three mounting methods are available:

- 0. V
- 1. Z
- 2. N (small pipe)

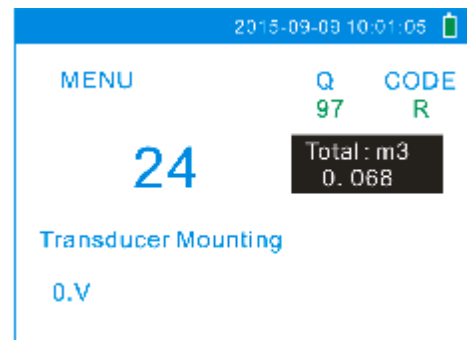

Transducer Spacing

The operator must mount the transducer according to the transducer spacing displayed (be sure that the transducer spacing is measured precisely during installation). The system will display the data automatically after the pipe parameter has been entered.

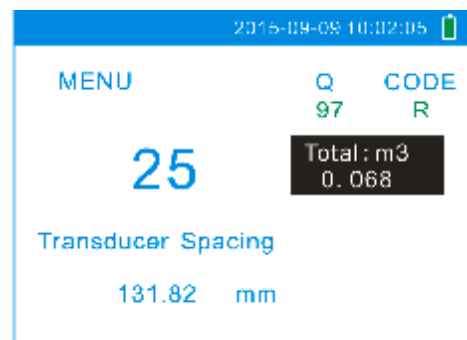





Initial Parameter Setups and Save

Load and save the parameters. 18 different sets of setup conditions/groups are available to load and save by three methods:

- 0. Entry to Save
- 1. Entry to Load
- 2. To Browse

Select "Entry to Save", press . An ID code and the original parameters are displayed in the window. Press UP or DOWN ARROW to move the ID code, then press the  key again to save the current parameter in the current ID file.

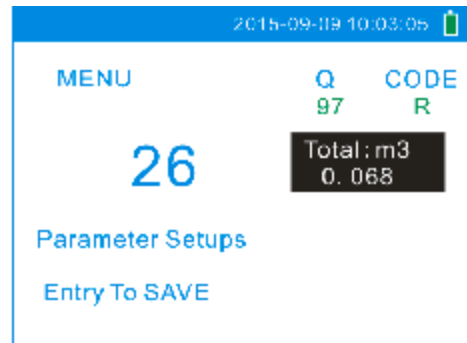

Cross-Sectional Area

Display the cross-sectional area inside the pipe.

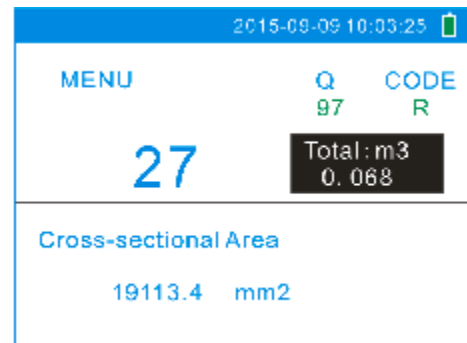

Holding With Poor Sig

Select "Yes" to hold last good flow signal displayed if the flowmeter experiences a poor temporary signal condition. This function will allow continued data calculation without interruption.

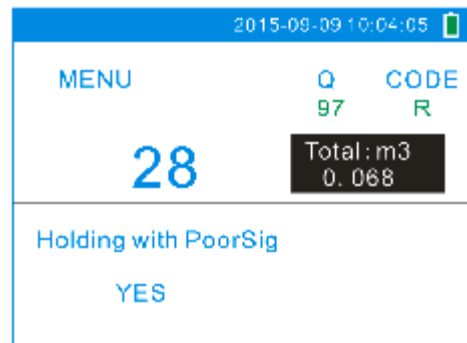

Empty Pipe Setup

This parameter is used to overcome the possible problems that usually show up when the pipe being measured is empty. Since signals can be transmitted through the pipe wall, the flow meter may still read a flow while measuring an empty pipe. To prevent this from happening, you can specify a value. When the signal quality falls below this value, the measurement stops automatically. If the flow meter is already able to stop measuring when the pipe is empty, a value in the range of 30 to 40 should also be entered in this

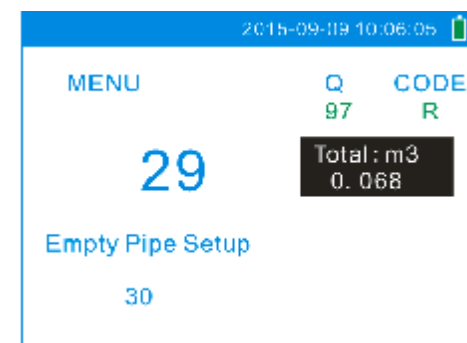

window to ensure no measurement when the pipe is empty.



Measurement Units

Select the measurement unit as follows:

- 0. Metric
- 1. English

Factory default is metric.

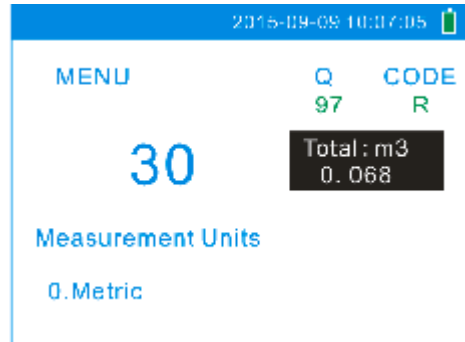

Flow Rate Units Options

The following flow rate units are available:

- 0. Cubic Meters (m3)
- 1. Liters (l)
- 2. USA Gallons (GAL)
- 3. Imperial Gallons (Imp gal)
- 4. Million Gallons (mg)
- 5. Cubic Feet (cf)
- 6. USA Barrels (US bbl)
- 7. Imperial Barrels (Imp bbl)
- 8. Oil Barrels (Oil bbl)

The following time units are available:

/Day /Hour /Min /Sec

Factory default is Cubic Meters/hour.

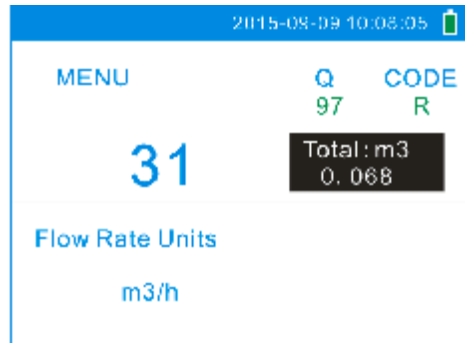

Totalizer Units Options

Select Totalizer units. The available unit options are as same as those found in Window M31. The user can select units as their required.

Factory default is Cubic Meters.

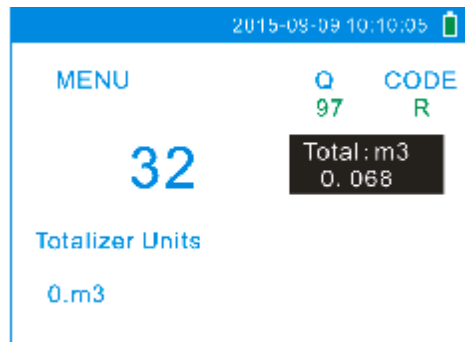

Totalizer Multiplier Options

The totalizer multiplier acts as the function to increase the totalizer indicating range. Meanwhile, the totalizer multiplier can be applied to the positive totalizer, negative totalizer and net totalizer at the same time. The following options are available:

- 0.x 0.001 (1E-3)

- 1.x 0.01
- 2.x 0.1
- 3.x 1
- 4.x 10
- 5.x 100
- 6.x 1000
- 7.x 10000(1E+4)

Factory default factor is x1



ON/OFF POS Totalizer

On/OFF POS Totalizer. "ON" indicates the totalizer is turned on, while "OFF" indicates it is turned off. When it is turned off, the net totalizer displays in Window M02 will not change. Factory default is "ON".

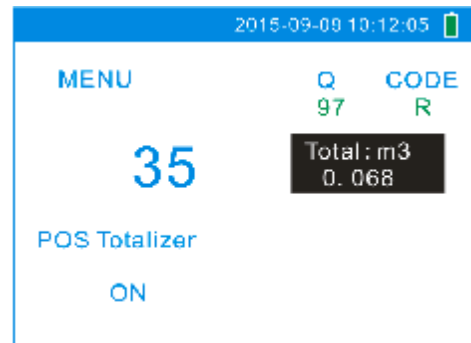

ON/OFF NEG Totalizer

ON/OFF NEG totalizer. "ON" indicates the totalizer is turned on. When it is turned off, the negative totalizer displays in Window M03.

Factory default is "ON".

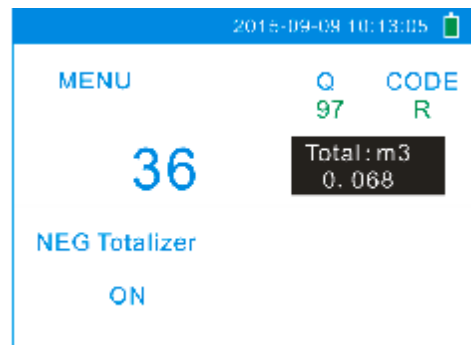

Totalizer Reset

Totalizer reset; all parameters are reset. Press **Enter**; move **^/+** or **v/-** arrow to select "YES" or "NO". After "YES" is selected, the following options are available:

- None
- All
- NET Totalizer

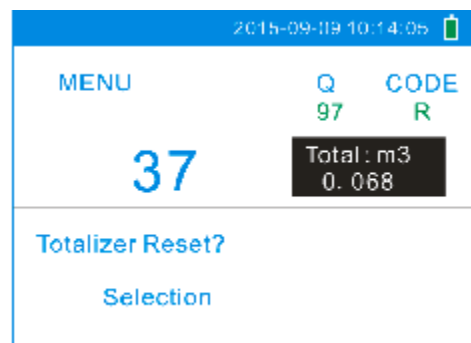

POS Totalizer

NEG Totalizer

Reset

If the user wants to delete all the already set parameters and set back to the factory default, select reset in this window and then the flowmeter will reset to be the factory default automatically.



Attention

This operation will cancel all the data and revert back to factory default. Be careful with this operation.



Manual Totalizer

The manual totalizer is a separate totalizer. Press **Enter** to start, and press **Enter** to stop it. It is used for flow measurement and calculation.

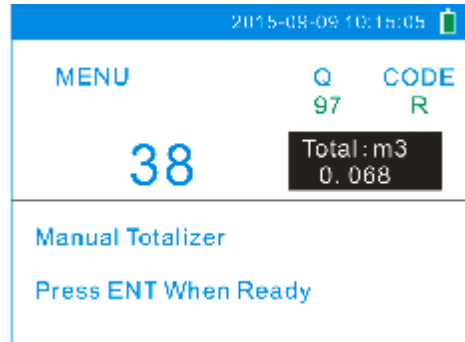

Damping

The damping factor ranges from 0~999 seconds. 0 indicates no damping; 999 indicate the maximum damping.

The damping function will stabilize the flow display. Usually a damping factor of 3 to 10 is recommended in most applications.

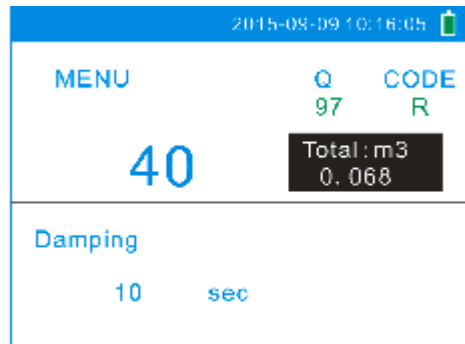

Low Flow Cutoff Value

If the flow rate falls below the low flow cutoff value, the flow indication is driven to zero. This function can prevent the flowmeter from reading flow after pump shut down but there is still liquid movement in the pipe, which will result in accumulative error.

Generally, 0.03m/s is recommended to enter as the low flow cutoff point. The low flow cutoff value has no relation to the measurement results once the velocity increases over the low flow cutoff value.

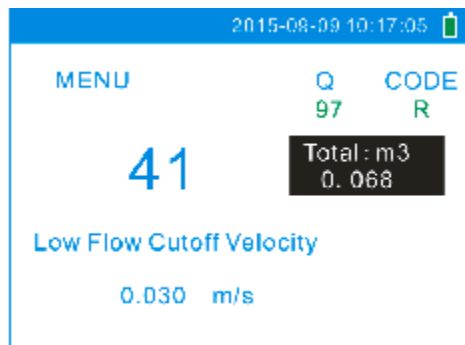



Set Zero

When fluid is in the static state (no movement), the displayed value is called "Zero Point". When "Zero Point" is not at true zero in the flowmeter, the difference is going to be added into the actual flow values and measurement differences will occur in the flowmeter.

Set zero must be carried out after the transducers are installed and the flow inside the pipe is in the absolute static state (no liquid movement in the pipe). Thus, the "Zero Point" resulting from different pipe mounting location and parameters can be eliminated. The measuring accuracy at low flow is enhanced by doing this function and flow offset is eliminated.

Press , wait for the processing instructions at the

bottom right corner of the display to reach 0.

Performing Set zero with existing flow may cause the flow to be displayed as "0". If so, it can be recovered via window M43.



Reset Zero

Select "YES"; reset "Zero Point" which was set by the user.



Manual Zero Point

This method is not commonly used. It is only suitable for experienced operators to set zero under conditions when it is not preferable to use other methods.

Enter the value manually to add to the measured value to obtain the actual value. For example:

- Actual measured value = 250 m3/H;
- Value Deviation = 10 m3/H;
- Flowmeter Display = 240 m3/H.
- Normally, set the value as "0".

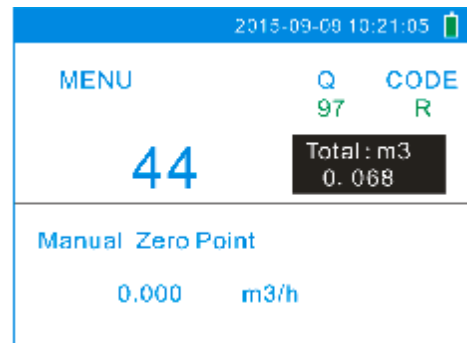
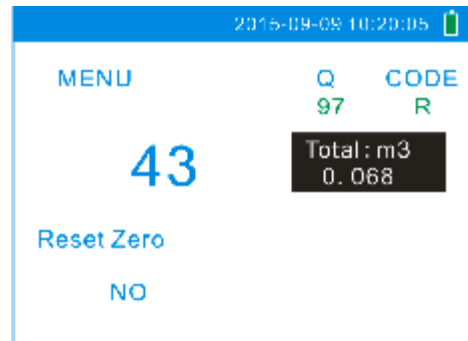
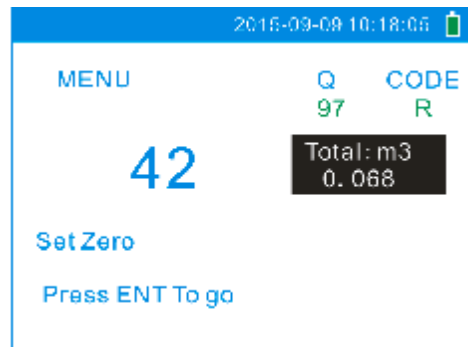



Scale Factor

The scale factor is used to modify the measurement results. The user can enter a numerical value other than "1" according to calibration results.

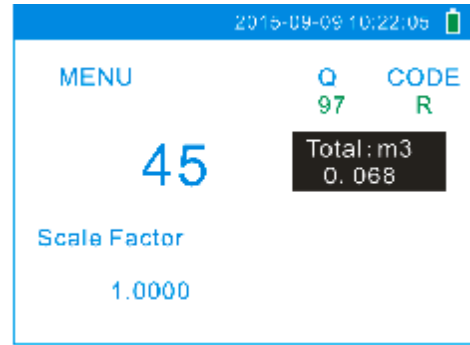

Network IDN

Input system identifying code, these numbers can be selected from 1~247 except that 13 (ODH ENTER), 10 (0AH Newline), 42 (2AH *) and 38 (26H&) are reserved. System IDN is used to identify the flowmeter to a network.

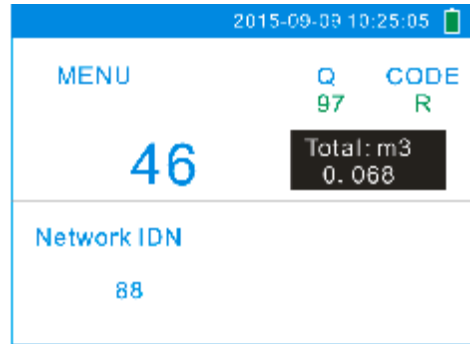

System Lock

Lock the instrument.

Once the system is locked, any modification to the system is prohibited, but the parameter is readable. "Unlock" using your designated password. The password is composed of 6 numbers.

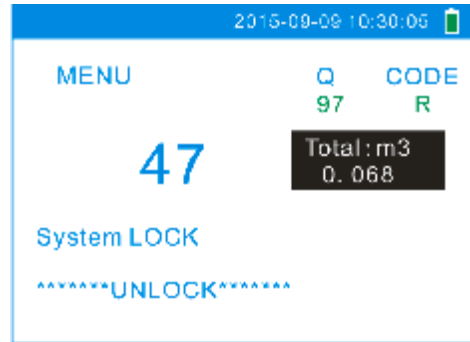

Segmented Correction

ON: Turn on the Sectional Correction Function;OFF: Turn off the Sectional Correction Function (optional)

Only when it is "ON", the settings of the Sectional Correction Value in M49 will be workable.

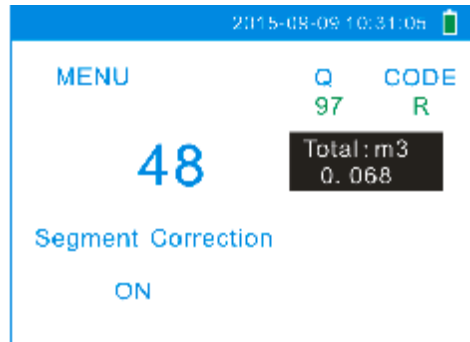



Segment Factor

You need to input the password "115800", then press **Enter** key to expand. Expand only in the current period, automatically shut down when the power is cut off. You can set 16 groups correction coefficient for sectionally correcting measurement results. The user can input the actual scale factor, referring to the calibration results.

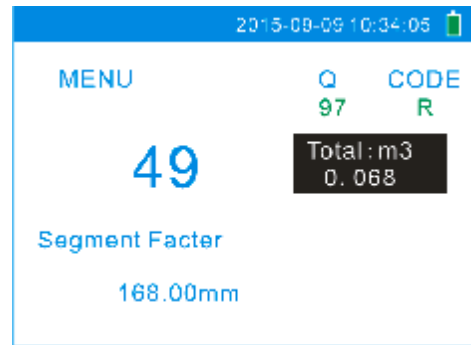

Current Loop Mode Select

- 0. 4-20mA flow;
- 1. 4-20mA Velocity.

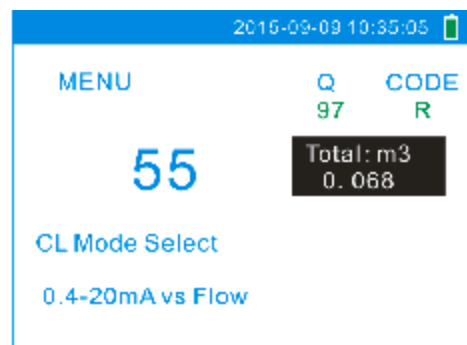

CL 4mA Output Value

Set the CL output value according to the flow value at 4mA. The flow unit's options are as same as those in Window M31. Once "velocity 4-20mA" is selected in Window M55, the unit should be set as m/s if it is the velocity unit selected.

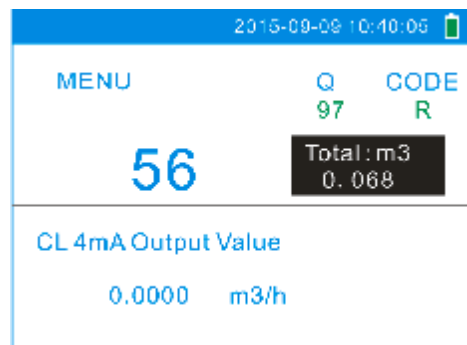

20mA Output Value

Set the CL output value according to the flow value at 20mA. The flow unit is the as same as that found in Window M31. Once "velocity 4-20mA" is selected in Window M55, the unit should be set as m/s, if m/s is the velocity selection.

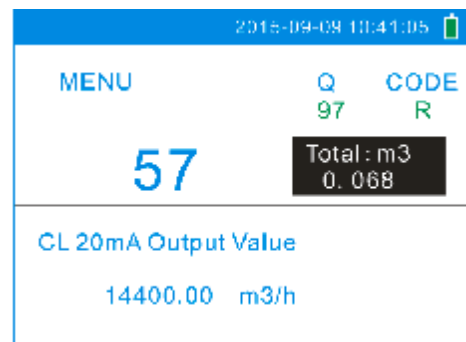



CL Check Verification

Check if the current loop has been calibrated before leaving the factory. Press **Enter** move **^/+** or **v/-** separately to display 4mA, 20mA, and at the same time, check with an ammeter to verify that CL output terminals M31 and 32 agree with the displayed values. It is necessary to re-calibrate the CL if it is over the permitted tolerance. For more information, refer to "Analog Output Calibration".



CL Current Output

Display CL current output. The display of 10.0000mA indicates that CL current output value is 10.0000mA. If the difference between displaying value and CL output value is too large, the current loop then needs to be re-calibrated accordingly.



Date and Time Settings

The format for setting time setting is 24 hours. Press **Enter**, wait until ">" appears, the modification can be made.



ESN

Display electronic serial number (ESN) of the instrument. This ESN is the only one assigned to each flowmeter ready to leave the factory. The factory uses it for file setup and for management by the user.

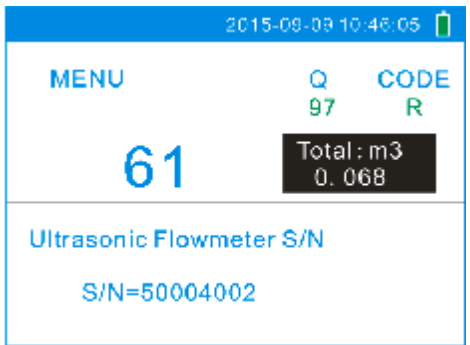
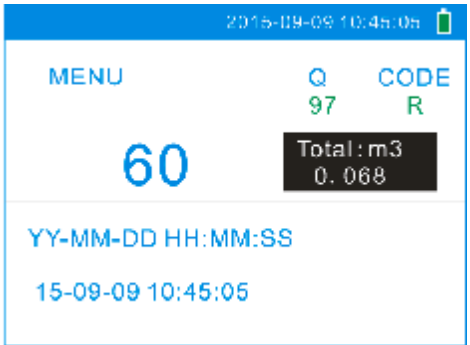
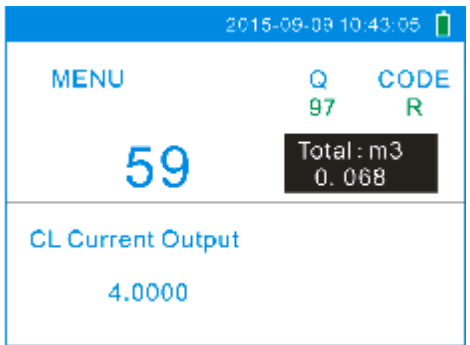
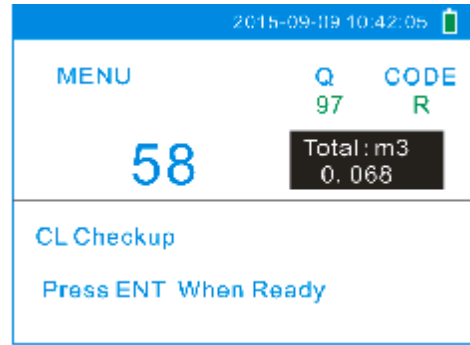



Serial Port Settings

This window is used for serial port setting. Serial port is used to communicate with other instruments. The serial port parameters setting of the instrument that applies the serial port connection must be consistent. The first selected data indicates baud rate, 9600, 19200, 38400, 56000, 57600, 115200 are available.

The second option indicates parity bit, None (No verification).

Data length fixed to 8;

Stop bit length for a fixed length.

The factory default serial port parameter is "9600, None".



Set FO Frequency Range

Set up high FO frequency range. It must be higher than the low FO frequency. Ranges from 1-9999Hz.

Factory default is 1~1001 Hz.

Note: The frequency output is transmitted through OCT Serial Port; therefore the OCT must be set to the frequency output mode.

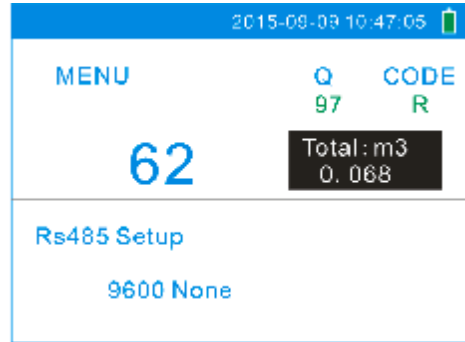

Low FO Flow Rate

Set up low FO flow rate, i.e. the corresponding flow value when output signal frequency is at the lowest FO frequency. For example, when the low FO frequency is 1000Hz, low FO flow rate is 100m3/h then when the frequency output is 1000Hz, the low flow at this moment measured by the Flowmeter is 100m3/h.

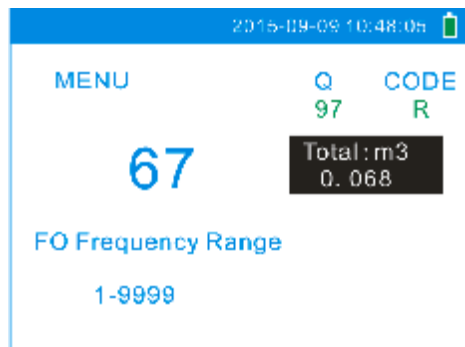

High FO Flow Rate

Enter the high FO flow rate, i.e. the corresponding flow value when frequency output signal is at highest FO frequency. For example, when the low FO frequency is 3000Hz, low FO flow rate is 1000m3/h then when the frequency output is 3000Hz, the low flow at this moment measured by the Flowmeter is 1000m3/h.

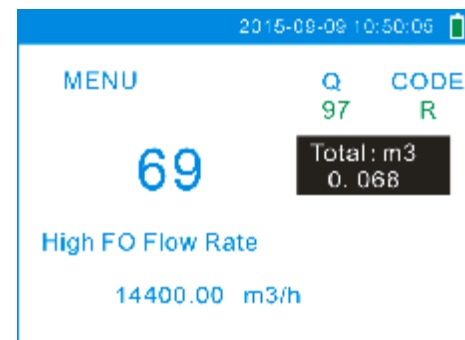
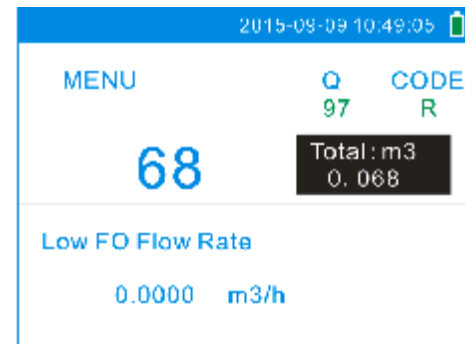



Working Timer

Display the total working hours of the Flowmeter since last reset. It is displayed by HH:MM:SS. If it is necessary to reset it, press **Enter**, and select "YES".

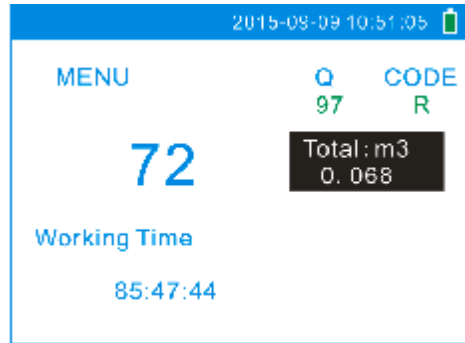

Alarm #1 Low Value

Enter the low alarm value. Relevant alarm is turned on in Windows M78 and M79; any of the measured flow, which is lower than the low value, will activate the alarm in the OCT hardware or Relay output signal.

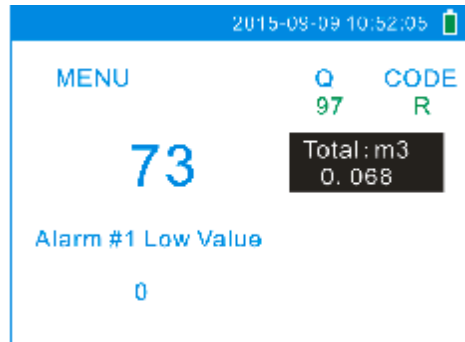

Alarm #1 High Value

Enter the high alarm value. Relevant alarm is turned on in Windows M78 and M79; any of the measured flow, which is higher than the high value, will activate the alarm in the OCT hardware or Relay output signal.

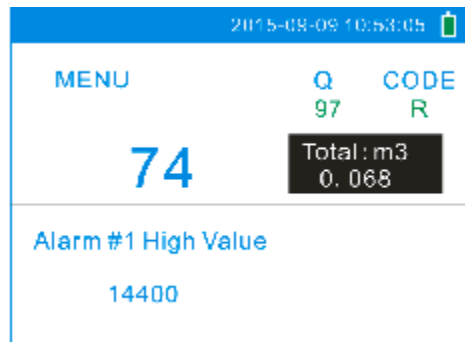

Beeper Setup

Set up the beeper on-off state.

- 0. ON Beeper ON
- 1. OFF Beeper OFF

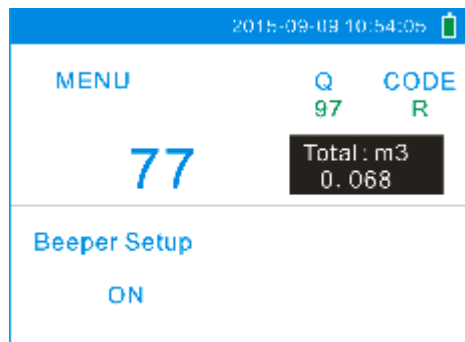



Signal Strength and Signal Quality

Display the measured signal strength and signal quality Q value upstream and downstream.

Signal strength is indicated from 00.0~99.9. A reading of 00.0 indicates no signal detected, while 99.9 indicates maximum signal strength. Normally the signal strength should be ≥ 60.0 .

Signal quality Q is indicated by 00~99. Therefore, 00 indicates the poorest signal while 99 indicates the best signal. Normally, signal quality Q value should be better than 50.

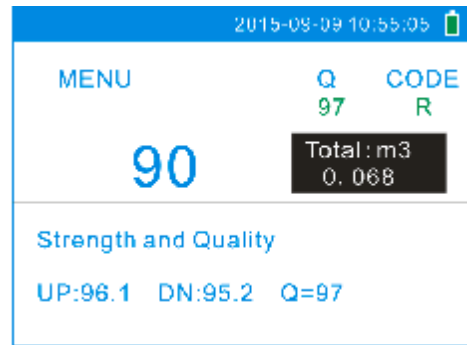

TOM/TOS*100

Display the ratio between the actual measured transmit time and the calculated transmit time according to customer's requirement. Normally the ratio should be $100\pm 3\%$. If the difference is too large, the user should check that the parameters are entered correctly, especially the sound velocity of the fluid and the installation of the transducers. This data is of no use before the system is ready.

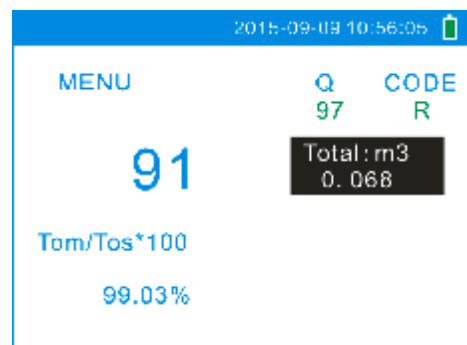

Fluid Sound Velocity

Display the measured fluid sound velocity. Normally this value should be approximately equal to the entered value in Window M21. If the difference is too large, it probably results from an incorrect value entered in Window M21 or improper installation of the transducers.

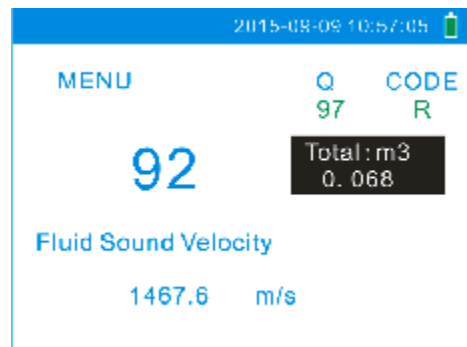

Total Time and Delta Time

Display the measured ultrasonic average time (unit: nS) and delta time of the upstream and downstream (unit: nS) time. The velocity calculation in the flowmeter is based on the two readings. The delta time is the best indication that the instrument is running steadily. Normally the fluctuation in the ratio of the delta time should be lower than 20%. If it is not, it is necessary to check if the transducers are installed properly or if the parameters have been entered correctly.

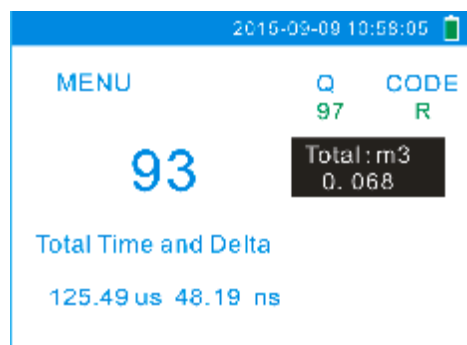



Reynolds Number and Factor

Display the reynolds number that is calculated by the flowmeter and the factor that is set currently by the flowmeter. Normally this scaling factor is the average of the line and surface velocity factor inside the pipe.

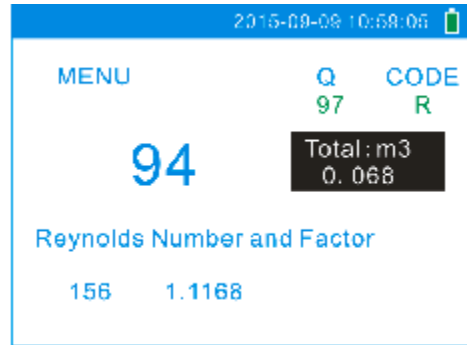

Time Fixed Delay

Display the time fixed delay.

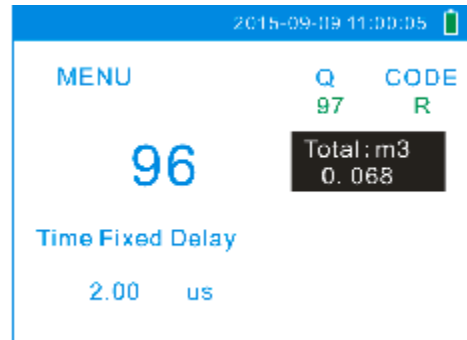

Analog Output Verification

Please refer to the Menu 58 "4~20mA Analog Output Verification".

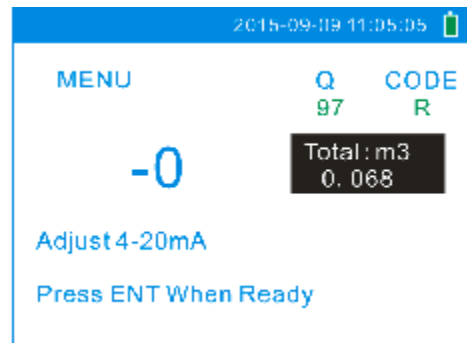

6. Error Diagnoses

The ultrasonic flowmeter has advanced self-diagnostics functions and displays any errors in the upper right corner of the LCD via definite codes in a date/time order. Some errors can be detected during normal operation. Undetectable errors caused by unskilled operation, incorrect settings and unsuitable measurement conditions can be displayed accordingly during work. This function helps the user detect the errors and find causes quickly; thus, problems can be solved in a timely manner according to the solutions listed in the following tables. The error codes caused by incorrect settings and the detected signal can be displayed in Window M08.

6.1 Table 1. Error Codes and Solutions (during operation)

Codes	M08 Display	Causes	Solutions
*R	System Normal.	* System normal.	
*I	Signal Not Detected.	<ul style="list-style-type: none"> * Signal not detected. * Spacing is not correct between the transducers or not enough coupling compound applied to face of transducers. * Transducers installed improperly. * Scale is too thick. * New pipe liner. 	<ul style="list-style-type: none"> * Attach transducer to the pipe and tighten it securely. Apply a plenty of coupling compound on transducer and pipe wall. * Remove any rust, scale, or loose paint from the pipe surface. Clean it with a file. * Check the initial parameter settings. * Remove the scale or change the scaled pipe section. Normally, it is possible to change a measurement location. The instrument may run properly at a new site with less scale. * Wait until liners solidified and saturated
*G	Adjusting Gain (Display in Windows M01).	* Adjusting gain for normal measurement.	

6.2 Frequently Asked Questions and Answers

Question: New pipe, high quality material, and all installation requirements met: why still no signal detected ?

Answer: Check pipe parameter settings, installation method and wiring connections. Confirm if the coupling compound is applied adequately, the pipe is full of liquid, transducer spacing agrees with the screen readings and the transducers are installed in the right direction.

Question: Old pipe with heavy scale inside, no signal or poor signal detected: how can it be resolved?

Answer: Check if the pipe is full of fluid. Try the Z method for transducer installation (If the pipe is too close to a wall, or it is necessary to install the transducers on a vertical or inclined pipe with flow upwards instead of on a horizontal pipe).

Carefully select a good pipe section and fully clean it, apply a wide band of coupling compound on each transducer face (bottom) and install the transducer properly.

Slowly and slightly move each transducer with respect to each other around the installation point until the maximum signal is detected. Be careful that the new installation location is free of scale inside the pipe and that the pipe is concentric (not distorted) so that the sound waves do not bounce outside of the proposed area.

For pipe with thick scale inside or outside, try to clean the scale off, if it is accessible from the inside. (Note: Sometimes this method might not work and sound wave transmission is not possible because of

the a layer of scale between the transducers and pipe inside wall).

Question: Why is the CL output abnormal?

Answer: Check to see if the desired current output mode is set in Window M55.

Check to see if the maximum and minimum current values are set properly in Windows M56 and M57.

Re-calibrate CL and verify it in Window M49.

Question: Why is the flow rate still displayed as zero while there is fluid obviously inside the pipe and a symbol of "R" displayed on the screen?

Answer: Check to see if "Set Zero" was carried out with fluid flowing inside the pipe (Refer to Window M42). If it is confirmed, recover the factory default in Window M43.

7. Product Overview

7.1 Introduction

The Model P118i Ultrasonic Flowmeter is a state-of-the-art universal transit-time flowmeter designed using ARM technology and low-voltage broadband pulse transmission. While principally designed for clean liquid applications, the instrument is tolerant of liquids with the small amounts of air bubbles or suspended solids found in most industrial environments.

7.2 Features of Flowmeter

With distinctive features such as high precision, high reliability, high capability and low cost, the flowmeter features other advantages:

1. With ARM COMA chip, low power consumption, high reliability, anti-jamming and outstanding benefits.
2. Clear, user-friendly Menu selections make flowmeter simple and convenient to use. U.S., British and Metric measurement units are available. Meanwhile, almost all-universal measurement units worldwide may be selected to meet customer's requirements.
3. With the SD Card, 512 files can be stored; the time interval can be within 1 second.
4. Parallel operation of positive, negative and net flow totalizer with scale factor and 7 digit display.

The flow meter ensures the higher resolution and wider measuring range by the 0.04nS high resolution, high linearity and high stability time measuring circuit and 32 bits digits processing program.

7.3 Theory of Operation

This Ultrasonic Flowmeter and Analyzer adopts the time-difference measurement principle. The ultrasonic waves emitted by the sensor in a fluid, the flowing in the propagation direction of acoustic wave propagation velocity downstream increases, decreases the upstream direction, have different propagation distance in the same transmission time, measure the flow rate according to the difference of the transmission time and the fluid flow velocity.

When the ultrasonic signal is transmitted through the flowing liquid, there will be a difference between the upstream and downstream transit time (travel time or time of flight), which is proportional to flow velocity, according to the formula below.

$$V = \frac{MD}{\sin 2q} \times \frac{\Delta T}{T_{up} \cdot T_{down}}$$

Remarks:

V Medium Velocity

M Ultrasonic frequency of reflection

D Pipe Diameter

θ The angle between the ultrasonic signal and the flow

T_{up} Transit time in the forward direction

T_{down} Transit time in the reverse direction

$$\Delta T = T_{up} - T_{down}$$

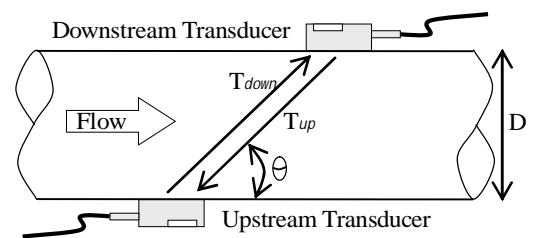

7.4 Applications

Water, sewage (with low particle content) and seawater; Acid alkali liquor, edible oil, diesel oil, crude oil, alcohol, beer, etc.

Water plant and sewage treatment plants;

Plant irrigation;

Metallurgy and mining applications (cooling water and acid recovery, for example)

Petroleum and chemicals; Food and medicine;

Energy-saving monitoring, water-saving management and flow inspection, flow tracking and collection, computerized management and monitoring network system.

7.5 Specifications

Performance Specifications	
Flow range	± (0.03 ~ 40) ft/s ± (0.01 ~ 12) m/s
Accuracy	± 0.5% of measured value
Repeatability	0.15%.
Linearity	± 0.5%.
Pipe Size	0.6" ~ 240" (15mm ~ 6000mm)
Function Specifications	
Output	Analog output: 4~20mA, Max 750 Ω.
SD card	Storage: 2GB (To prevail in kind); Max: 512 files; Interval: 1 ~ 60 seconds.
Power Supply	rechargeable Lithium Battery Power (continuous operation of main battery 10 hours).
Keypad	Tactile Keys.
Display	3.5 inch TFT color screen(320 × 240), backlit LCD.
Temperature	Transmitter: -10°C ~ 50°C (-40°F to 176°F); Measuring medium: - 40°C ~ 80°C (Standard).
Humidity	0 ~ 99% RH, non-condensing.
Physical Specifications	
Transmitter	NEMA13 (IP54).
Transducer	Encapsulated design, IP68; Standard cable length: 5m.
Weight	Transmitter: 1kg.

8. Appendix 1 - Flow Application Data

8.1 Sound Velocity and Viscosity for Fluids Commonly Used

Fluid	Sound Velocity (m/s)	Viscosity
water 20°C	1482	1.0
water 50°C	1543	0.55
water 75°C	1554	0.39
water 100°C	1543	0.29
water 125°C	1511	0.25
water 150°C	1466	0.21
water 175°C	1401	0.18
water 200°C	1333	0.15
water 225°C	1249	0.14
water 250°C	1156	0.12
Acetone	1190	
Carbine	1121	

Ethanol	1168	
Alcohol	1440	1.5
Glycol	1620	
Glycerin	1923	1180
Gasoline	1250	0.80
Benzene	1330	
Toluene	1170	0.69
Kerosene	1420	2.3
Petroleum	1290	
Retinal	1280	
Aviation kerosene	1298	
Peanut oil	1472	
Castor oil	1502	

8.2 Sound Velocity for Various Materials Commonly Used

Pipe Material	Sound Velocity (m/s)
Steel	3206
ABS	2286
Aluminum	3048
Brass	2270
Cast iron	2460
Bronze	2270
Fiber glass-epoxy	3430
Glass	3276
Polyethylene	1950
PVC	2540

Liner Material	Sound Velocity (m/s)
PTFE	1225
Titanium	3150
Cement	4190
Bitumen	2540
Porcelain enamel	2540
Glass	5970
Plastic	2280
Polyethylene	1600
PTFE	1450
Rubber	1600

8.3 Sound Velocity In Water (1 atm) At Different Temperatures

t(°C)	v(m/s)
0	1402.3
1	1407.3
2	1412.2
3	1416.9
4	1421.6
5	1426.1
6	1430.5
7	1434.8
8	1439.1
9	1443.2
10	1447.2
11	1451.1
12	1454.9
13	1458.7
14	1462.3
15	1465.8
16	1469.3
17	1472.7
18	1476.0
19	1479.1
20	1482.3
21	1485.3
22	1488.2
23	1491.1
24	1493.9
25	1496.6
26	1499.2
27	1501.8
28	1504.3
29	1506.7
30	1509.0
31	1511.3
32	1513.5

33	1515.7
34	1517.7
35	1519.7
36	1521.7
37	1523.5
38	1525.3
39	1527.1
40	1528.8
41	1530.4
42	1532.0
43	1533.5
44	1534.9
45	1536.3
46	1537.7
47	1538.9
48	1540.2
49	1541.3
50	1542.5
51	1543.5
52	1544.6
53	1545.5
54	1546.4
55	1547.3
56	1548.1
57	1548.9
58	1549.6
59	1550.3
60	1550.9
61	1551.5
62	1552.0
63	1552.5
64	1553.0
65	1553.4
66	1553.7

67	1554.0
68	1554.3
69	1554.5
70	1554.7
71	1554.9
72	1555.0
73	1555.0
74	1555.1
75	1555.1
76	1555.0
77	1554.9
78	1554.8
79	1554.6
80	1554.4
81	1554.2
82	1553.9
83	1553.6
84	1553.2
85	1552.8
86	1552.4
87	1552.0
88	1551.5
89	1551.0
90	1550.4
91	1549.8
92	1549.2
93	1548.5
94	1547.5
95	1547.1
96	1546.3
97	1545.6
98	1544.7
99	1543.9

Please contact the factory for other sound of the velocity of fluids and materials.

