

Moisture Meter w/ Psychrometer

850003

Instruction Manual

TABLE OF CONTENTS

| | |
|--------------------------------------|----|
| 1. Important safeguards..... | 3 |
| 2. Battery warnings..... | 4 |
| 3. Intended use..... | 4 |
| 4. Product description..... | 5 |
| 5. Operations..... | 8 |
| 6. Auto power-off..... | 9 |
| 7. Changing the units..... | 9 |
| 8. Viewing Min/Max measurements..... | 9 |
| 9. Measuring tips..... | 10 |
| 10. Calibration..... | 10 |
| 11. Humidity meter mode..... | 11 |
| 12. Setting humidity alarm..... | 12 |
| 13. Moisture meter mode..... | 13 |
| 14. Pinless measurement..... | 13 |
| 15. Pin-type probe measurement..... | 14 |
| 16. Setting moisture alarm..... | 15 |
| 17. Vapor pressure mode..... | 16 |
| 18. Logbook..... | 16 |
| 19. Changing batteries..... | 17 |
| 20. Cleaning and maintenance..... | 18 |
| 21. Specifications..... | 19 |
| 22. Warranty..... | 20 |

IMPORTANT SAFEGUARDS



Read these instructions carefully and retain them for future use. If this product is passed to a third party, then these instructions must be included.

When using electrical appliances, basic safety precautions should always be followed to reduce the risk of fire, electric shock, and/or injury to persons including the following:

⚠ CAUTION Risk of injury! The pin-type probes are very sharp. Be careful while handling. Cover the pins with the protective cap when the product is not in use. In addition, the pin-type probes can damage the measured surface. For non-invasive measurement use the pinless moisture sensor on the back of the product.

- Do not use if the product appears damaged or if it is not working properly. If in doubt, replace the product.
- Do not attempt repairs. There are no user serviceable parts.
- Do not expose the product itself to moisture. Otherwise the product can get damaged.





Battery Warnings

- Exhausted batteries should be immediately removed from product and properly disposed.
- Keep batteries out of the reach of children.
- Do not dispose of batteries in fire.
- Remove batteries from product if it is not to be used for an extended period of time.
- If the battery leaks avoid contact with skin and eyes. Rinse affected areas immediately with plenty of clean water, then consult a doctor.

Intended Use

- This product is intended for measuring air humidity and moisture content in wood, paper, cardboard and building structures (wood, mortar, concrete or plaster).
- This product does not provide a replacement for an officially calibrated measuring device.
- This product is intended to be used in dry areas only. Do not use it in rainy conditions.
- No liability will be accepted for damages resulting from improper use or non-compliance with these instructions.

Product Description

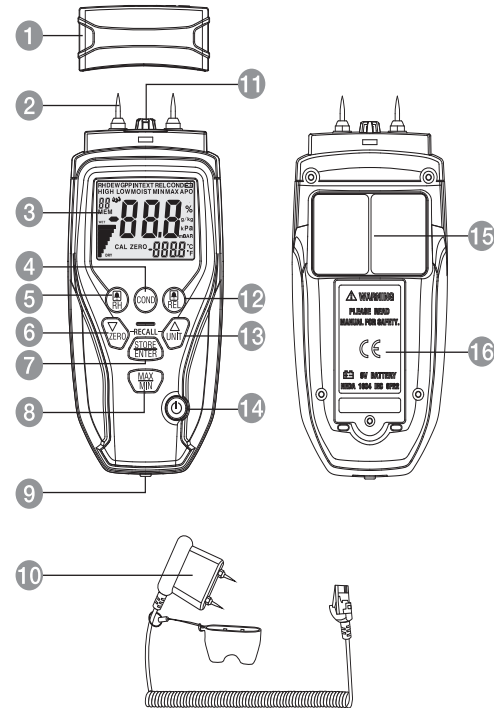

- 1 Protective cap (with calibration instrument)
- 2 Pin-type probe
- 3 Display
- 4 COND button
- 5 RH button
- 6 ▼ ZERO button
- 7 STORE/ENTER button
- 8 MAX/MIN button
- 9 External probe socket (RJ45)
- 10 External pin-type probe
- 11 Humidity sensor
- 12 REL button
- 13 ▲ UNIT button
- 14 ⏻ on/off button
- 15 Pinless moisture sensor
- 16 Battery compartment cover

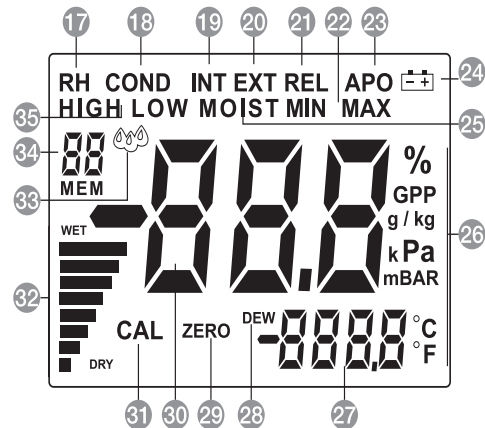

- 17 RH indicator
- 18 COND indicator
- 19 INT pinless moisture indicator
- 20 EXT pin-type probe moisture indicator
- 21 REL indicator
- 22 MAX / MIN indicators
- 23 APO indicator
- 24  low battery indicator
- 25 MOIST indicator

- 26 Unit indicator
- 27 Second value
- 28 **DEW** indicator
- 29 **ZERO** indicator
- 30 First value
- 31 **CAL** indicator
- 32 Moisture level scale
- 33 Dew point indicator
- 34 Logbook indicator
- 35 **HIGH / LOW** indicators

Operation

Switching the product on

Press the on/off button  (14). The product beeps once. The display (3) lights up.

Switching the product off

Press the on/off button  (14) again. The display (3) goes off.

Auto power-off (APO)

- This product switches off automatically after 30 minutes of inactivity. The **APO** indicator (23) is shown on the display (3).
- The product emits a warning beep 15 seconds before switching off.
- To disable the auto power-off feature, while switching on, press the **REL** button (12).

Changing the units

Press and hold the  **UNIT** button (13) for 3 seconds to change the measurement unit.

Viewing the minimum/maximum measurements

- Press the **MAX/MIN** button (8) to show the lowest measured value. The **MIN** indicator (22) is shown on the display (3).
- Press the **MAX/MIN** button (8) again to show the highest measured value. The **MAX** indicator (22) is shown on the display (3).



- Press the **MAX/MIN** button (8) again to show the current measurement value. The **MAX** indicator (22) goes off.

Measuring tips

- Measure several spots and take an average value.
- Remove the bark from firewood if needed. Press the measuring pins against the grain in various places on the wood.
- Ensure that both measuring pins touch the surface of the material at the same time. Slightly increase the pressure on the measuring pins for rough surfaces.
- For delicate surfaces complete the measurement on a section that is not in the visible area.

Calibration

NOTICE To check the accuracy, align the contact points on the protective cap (1) with the pin-type probes (2). The T contact should output 18 %. The B contact should output 26 %.

- To calibrate the product, switch it on by pressing the on/off button  (14) and the **STORE/ENTER** button (7) simultaneously. The **CAL** indicator (31) is shown on the display (3).

Humidity meter mode

NOTICE The air humidity is measured by the humidity sensor (11).

- Remove the protective cap (1) to make a measurement.
- Press the **RH** button (5) to toggle between different humidity meter modes.

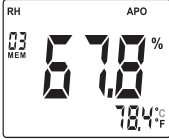
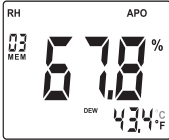
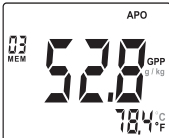
| Function | Display |
|---|---|
| <ul style="list-style-type: none"> • Relative humidity (%) • Ambient temperature (°F °C) |  |
| <ul style="list-style-type: none"> • Relative humidity (%) • Dew point temperature (°F °C) |  |
| <ul style="list-style-type: none"> • Absolute humidity (GPP g/kg) • Ambient temperature (°F °C) |  |

| Measurement | Range | Accuracy |
|------------------------|----------------|----------|
| RH measurement | 0–20 % | ±5 % |
| 68–86 °F (20–30 °C) | 20–80 % | ±3.5 % |
| | 80–99 % | ±5% |
| Air temperature | –20 to 158 °F | ±3.6 °F |
| | (–29 to 70 °C) | (2 °C) |

Setting the humidity alarm

- Press and hold the **RH** button (5) for 3 seconds. The product beeps and the **HIGH** indicator (35) is shown on the display (3).
- Set the high limit alarm using the ▲ (13) and ▼ (6) buttons. Press and hold to change the value faster.
- Confirm by pressing the **STORE/ENTER** button (7). The **LOW** indicator (35) is shown on the display (3).
- Set the low limit alarm using the ▲ (13) and ▼ (6) buttons. Press and hold to change the value faster.
- Confirm by pressing the **STORE/ENTER** button (7). The **LOW** indicator (35) goes off. The alarm is now set.

- If the measurement exceeded the lower or the higher limit, the product beeps continuously. The corresponding **HIGH** or **LOW** indicator (35) is shown on the display (3).

Moisture meter mode

NOTICE The moisture of an object is measured by the pin-type probe (2), the external pin-type probe (10), or the pinless moisture sensor (15).

Press the **REL** button (12) to toggle between the pin-type or pinless measurement.

Pinless measurement

In the pinless measurement mode, the **INT** indicator (19) is shown on the display (3).

| Function | Display |
|---|---------|
| • Moisture level in relation to absolute air humidity | |
| • Ambient temperature (°F °C) | |

- Hold the product up so that the moisture sensor (15) is not covered by your hand or by any surface or object. The reading displayed should be **0.0**. If not, the sensor must be calibrated. To do so, press and hold the ▼ **ZERO** button (6) for 2 seconds until the **ZERO** indicator (29) is shown on the display (3).
- Place the moisture sensor (15) against an object to measure its moisture.

Pin-type probe measurement

In the pin-type probe measurement mode, the **EXT** indicator (20) is shown on the display (3).

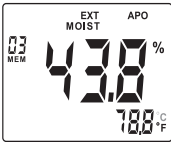
| Function | Display |
|--|---|
| <ul style="list-style-type: none"> • Moisture level in percent (%) • Dew point temperature (°F °C) |  |
| <ul style="list-style-type: none"> • This measurement can be done either by the pin-type probe (2), or by the external pin-type probe (10). • To use the external pin-type probe (10), connect it's plug to the pin-type probe socket (9). | |

- Do not use the pin-type probe (2) and the external pin-type probe (10) at the same time, as the measurements could be distorted.

| Measurement | Range | Accuracy |
|------------------|----------|----------|
| Moisture in wood | 6–99 % | ±5 % |
| Air temperature | 0–99.9 % | ±5 % |

NOTICE To check the accuracy, align the contact points on the protective cap (1) with the pin-type probes (2). The T contact should output 18 %. The B contact should output 26 %.

Setting the moisture alarm

- Press and hold the **REL** button (12) for 3 seconds. The product beeps and the **HIGH** indicator (35) is shown on the display (3).
- Set the high limit alarm using the ▲ (13) and ▼ (6) buttons. Press and hold to change the value faster.
- Confirm by pressing the **STORE/ENTER** button (7). The **LOW** indicator (35) is shown on the display (3).
- Set the low limit alarm using the ▲ (13) and ▼ (6) buttons. Press and hold to change the value faster.

- Confirm by pressing the **STORE/ENTER** button (7). The **LOW** indicator (35) goes off. The alarm is now set.
- If the measurement exceeded the lower or the higher limit, the product beeps continuously. The corresponding **HIGH** or **LOW** indicator is shown on the display (3).

Vapor pressure mode

To enter vapor pressure mode, press the **COND** button (4). The **COND** indicator (18) is shown on the display (3).

| Function | Display |
|--|---|
| Vapor pressure (kPa mBAR) calculated in place of the dew point (°F °C) |  |

Logbook

Store data

Press and hold the **STORE/ENTER** button (7) for 3 seconds. The product beeps once and the measurement is stored in the logbook.

View data

Press the **▼ ZERO** (6) and **▲ UNIT** (13) buttons simultaneously to open the logbook. The previous 20 records (measurements) are shown in reverse order. Use the **▼ ZERO** (6) or the **▲ UNIT** (13) button to navigate through these records.

NOTICE If the stored record was taken in the humidity mode, press the **RH** button (5) to toggle between 3 humidity modes.

Clear data

While in the main screen, press the **▼ ZERO** (6) and **STORE/ENTER** (7) buttons simultaneously for 5 seconds to clear all the records. The product beeps and **CLR** is shown on the display (3) .

Changing Batteries

NOTICE Replace the battery when the low battery indicator  (24) is shown on the display (3).

- Loosen the screw of the battery compartment cover (16) and remove it.
- Connect a new 9 V battery to the snap connector.





- Place the battery into the battery compartment and close it.
- Tighten the screw of the battery compartment cover (16).

Cleaning and Maintenance

NOTICE Switch the product off before cleaning.

NOTICE During cleaning do not immerse the product in water or other liquids. Never hold the product under running water.

Cleaning

- To clean the product, wipe with a soft, slightly moist cloth.
- Never use corrosive detergents, wire brushes, abrasive scourers, metal or sharp utensils to clean the product.

Storage

- Always attach the protective cap (1) when the product is not in use.
- Store the product in its original packaging in a dry area. Keep away from children and pets.

Specifications

| | |
|---|--------------------------------------|
| Power source: | 1 x 9 V battery |
| Operating temperature: | 32 °F to 122 °F (0 °C to 50 °C) |
| Storage temperature: | 14 °F to 140 °F (-10 °C to 60 °C) |
| Operating humidity at 68 °F to 86 °F (20 °C to 30 °C): | 0 – 99.9 % |
| Operating altitude: | max. 6562 feet (2000 meters) |



Battery Disposal



Do not dispose of used batteries with your household waste. Take them to an appropriate disposal/collection site.



WARRANTY

Sper Scientific warrants this product against defects in materials and workmanship for **one (1) year** from the date of purchase, and agrees to repair or replace any defective unit without charge. If your model has since been discontinued, an equivalent Sper Scientific product will be substituted if available. This warranty does not cover damage resulting from accident, misuse, or abuse of the product. To obtain warranty service, ship the unit postage prepaid to:

SPER SCIENTIFIC LTD,
8281 E. Evans Rd., Suite 103
Scottsdale, AZ 85260
(480) 948-4448

The defective unit must be accompanied by a description of the problem and your return address. Register your product online at www.sperwarranty.com within 10 days of purchase.