

## HD PIPE INSPECTION CAMERA SYSTEM



## INDUSTRIAL VISUAL INSPECTION TOOL

# USER MANUAL

Version 1.1

Please read this user manual carefully before using and keep it for future reference.  
Failure to understand operation procedures may result in product damage or/and physical injury.

# CONTENTS

<b>General Safety Information</b> .....	<b>1</b>
<b>Safety Instruction</b> .....	<b>1</b>
<b>Welcome</b> .....	<b>2</b>
<b>Features</b> .....	<b>2</b>
<b>Structure Introduction</b> .....	<b>3-5</b>
<b>Packing List</b> .....	<b>5</b>
<b>Specification</b> .....	<b>6</b>
<b>Installation</b> .....	<b>7</b>
Install cable reel to metal frame .....	7
Install camera head .....	7
Install control box .....	7
Uninstall control box.....	7
Install camera bracket.....	8
<b>Basic Operation</b> .....	<b>8</b>
Charge the device .....	8
Install SD card/USB storage device .....	8
Install wireless keyboard .....	8
<b>Operating Instruction</b> .....	<b>9-14</b>
Safety Precautions .....	9-10
1. Preparation .....	10
2. Power on the device .....	10
3. Camera inspection operating.....	10
4. Meter counter operating .....	10
5. Photo and video operating .....	10
6. Wireless keyboard operating .....	11
7. Playback videos/pictures .....	11
8. Deletion operating.....	11
9. System setup.....	11-12
10. Display setup operating .....	13-14
11. 2.4G monitor operating(optional function) .....	14
12. 512Hz transmitter (optional function) .....	14
13. End of work.....	14
<b>Troubleshooting</b> .....	<b>15</b>
<b>Maintenance Tips</b> .....	<b>16</b>
<b>Warranty Information</b> .....	<b>16</b>
<b>Return for Repair Policy</b> .....	<b>16</b>

FCC/CE Statements: This device complies with part 15 of the FCC Rules and standards including Low Voltage Device Directive 73/23/EEC.

EMC: Directive 89/336/EEC. It passed the subject tests by the authority concerned and is authorized to bear CE mark.

## GENERAL SAFETY INFORMATION

### WARNING!

Read and understand all safety warnings and instructions. Failure to follow all safety warnings and instructions listed below may result in electric shock, fire and/or serious personal injury.

## SAFETY INSTRUCTION

- Save this User Manual for future reference.
- Use only the original accessories especially the power adapter and lithium battery provided by the vendor to avoid possible risks to health and property, and thus meet all related legal regulations.
- The camera fully installed on the push cable and the unopened control box are waterproof, however, the keyboard and the DVR inside the control box are not. Do not expose them in water or rain when the control box is open, this will increase the risk of electrical shock and damage to the device.
- Do not drop, knock, shake or press hard on the device, inappropriate behavior may damage the internal electronic circuit board or deform the lens shape.
- Do not disconnect the SD card/USB storage device while recording or playing back as this may damage the system and/or the SD card/USB storage device.
- Always backup your data before connecting your SD card to this system and remember that always backup the data after using this system to avoid data damage/loss or accidental deletion. Memory devices should not be considered as a long term storage device.
- Keep the device and its accessories out of the reach of babies, toddlers, and children.
- When using the camera LED lights, do not use to close to human or animal eyes, particularly for babies, toddlers, and children to avoid injury.
- Do not use the unit to inspect environments known or suspected to contain exposed electrical wiring.
- Do not use the unit in the presence of high voltage equipment, flammable or explosive liquids/gases, hazardous chemicals, superheated liquid or heavy dust.
- Do not try to use the camera head to clear obstructions. This System is a diagnostic tool, not a drain cleaner. Using the camera head to clear obstructions could damage the camera head or cause it to be caught in the obstruction.
- Never use the solvents to clean any part of the system. Substance like acetone and other harsh chemicals can cause cracking of the camera waterproof ring and affecting its waterproofness.
- Turn off the system if it is not in use and keep routine maintenance.
- Some countries have regulations concerning batteries disposal. Please follow all applicable regulations.

## WELCOME

Thank you for purchasing our HIGH-DEFINITION PIPE INSPECTION CAMERA SYSTEM.

This pipe inspection camera system is designed as a HD real-time inspection camera and to unveil the internal objects and/or structures with the illumination of the highlight LEDs, it is specially designed for pipeline, sewer, drain, duct, chimney, plumbing, building, swimming pool, milk pipes, water mains, cable pipes, central air conditioning, pipes ventilation systems and other plumbing related sites, and many more where a pipe inspection camera system is required.

This system is suitable for pipes with inner diameter at 15mm-300mm(0.5"-12").

Ability to go through 90° bends in pipe with inner diameter at:

- 45mm (for 21mm camera with 5.3mm push rod),
- 32mm (for 12.8mm camera with 4.8mm push rod),
- 52mm (for 21mm camera with 6.8mm push rod).

## FEATURES

- Camera diameter 12.8mm (with push rod cable diameter 4.8mm cable) and 21mm (with 5.3mm or 6.8mm) are available.
- Camera head with sapphire glass lens cover and 304 stainless steel housing allow the camera to withstand repeated hits in various pipes.
- The LED brightness control button is used pulley button without breakpoint dimming.
- Whole system is waterproof when the camera head is installed and the control box is closed.
- 9"/13.3" IPS LCD color monitor with standalone power button to turn on/off the screen alone.
- On-Screen date & time stamp and distance counter.
- The meter counter reset button can recount the meter at any time as required.
- The Meter-Feet button can switch the length unit easily.
- Microphone for local audio recording, just one press on the audio button to turn on/off the audio recording.
- Wireless keyboard for text input on the real-time picture or video like a laptop's, very easy to operate.
- The external storage SD Card slot or USB port to store still pictures or videos.
- The cable reel is out of the control box for easy cleaning and won't cause dirty in the box.
- Rechargeable battery lasts up to 7.5 hours continuous work (9" DVR).
- Rotatable cable reel mounted in metal frame for convenient operation.
- All-in-One visual pipe inspection camera system with push rod fiberglass cable length 10/20/30/40m/50m and diameter  $\phi$ 4.8mm/5.3mm/6.8mm for options.
- Other optional functions:
  1. 512Hz transmitter for 12.8mm and 21mm camera
  2. Self-leveling for 21mm camera
  3. 512Hz transmitter and self-leveling for 21mm camera
  4. Wireless 2.4G 5inch monitor to synchronize viewing the host screen when collaborating with multiple people

STRUCTURE INTRODUCTION

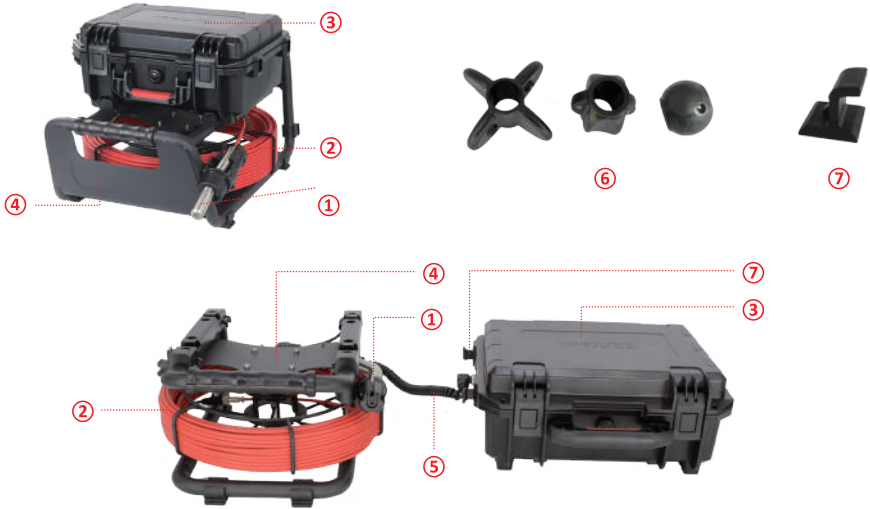



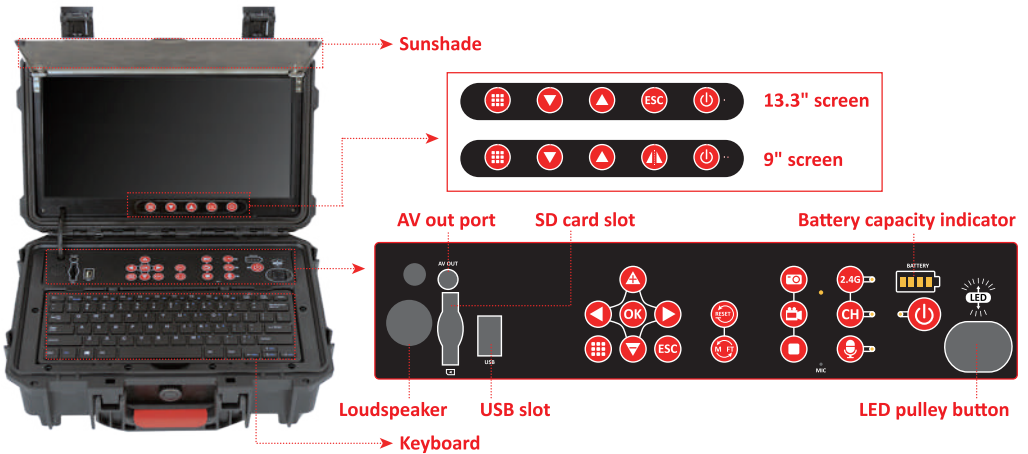

- ① Camera head
- ② Cable reel with meter counter
- ③ Control box
- ④ Metal frame and its accessories
- ⑤ Connection cable
- ⑥ Camera brackets
- ⑦ Pothook holder and Pothook















Control box:



## Display control buttons:

-  Menu button: To enter menu/confirm the selection
-  Up and Down button: Up and down select/Increase and decrease
-  ESC button: Exit the current interface and return to the previous interface
-  Flip button: To flip and mirror the image, RD/RN/RU/LD
-  Power button: Power on/off the display only

## Control board buttons:

-  Power button: Power on/off the whole system
-  LED pulley button: Rollup/rolldown to enhance/less the LED brightness
-  2.4G button: Turn on/off the 2.4G function
-  Channel switch button: Select the 2.4G channel to pair with the monitor
-  Audio button: Turn on/off the audio input
-  Camera button: Take picture/Pause or continue video playing
-  Video/OK button: Start video recording/Pause or continue video recording/Confirm the selection
-  Pause button: Stop video recording/ Stop video playing
-  Reset button: Set zero the meter counter
-  Meter-Feet switch button: Switch the meter unit from Meter to Feet or vice versa
-  Menu button: Enter menu
-  ESC button: Exit the current interface and return to the previous interface
-  Up and down button: Zoom in and zoom out/Up and down select/Increase and decrease
-  Left and Right button: Page down and page up /speed up and speed down
- SD card slot/USB slot for USB mobile hard disk: To insert memory device
- AV out port: Connect to a TV to get the same image from the display
- Loudspeaker: Audio output
- Keyboard: Wireless keyboard for text input on real-time image/video

## Ports and others:

Power charger port — Power indicator

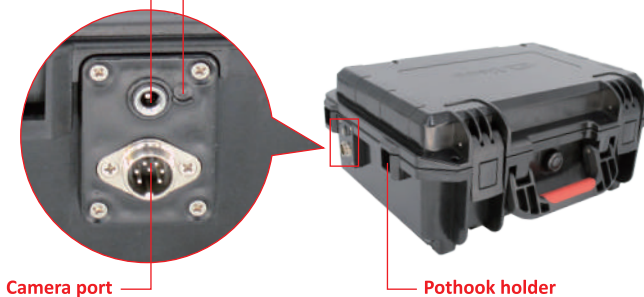

## Metal Frame and its accessories:

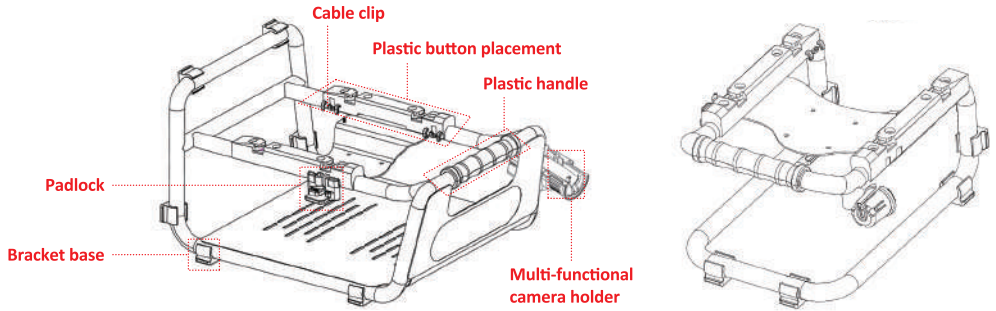

Camera holder/stopper: To hold the camera head/ stop the cable

Bracket base: To protect the metal frame

Plastic button placement: To install control box

Cable clip: To tidy the connection cable

Padlock: To automatically lock the control box

Plastic handle: To reduce pressure and prevent slip

## PACKING LIST

	<p>Metal frame X 1</p> <p>Cable reel with camera head X 1</p>	<ul style="list-style-type: none"> <li> 25mm bracket for 12.8mm camera X 1</li> <li> Screw X 2</li> <li> Screwdriver X 1</li> <li> Waterproof ring for 12.8mm camera X 2</li> </ul>	<ul style="list-style-type: none"> <li> DC12V Power supply X1</li> <li> Car charger X 1</li> </ul>
	<p>Control box with DVR &amp; wireless keyboard X 1</p> <p>Connection cable X 1</p>	<ul style="list-style-type: none"> <li> 46mm bracket for 21mm camera X 1</li> <li> 78mm bracket for 21mm camera X 1</li> <li> Screw and nut X 6</li> <li> Waterproof ring for 21mm camera X 6</li> <li> Screwdriver X 1</li> </ul>	<ul style="list-style-type: none"> <li> AV cable X 1</li> <li> Pothook X 2</li> <li> User Manual X 1</li> </ul>

**SPECIFICATION**

Item	21mm camera	12.8mm camera		
<b>General</b>	Operating Temperature	-10~50°C/+14~+122°F		
	Operating Humidity	30%RH~90%RH		
	Storage Temperature	-20~60°C/+4~+140°F		
	Power Adapter	Input: 110VAC~240V AC, Output: 12V DC 2A		
	Power Supply	DC 12 input		
	Current Consume	750mA Max		
	Battery Capacity	9000mAh Li-ion Battery		
	A Single Charge Work Time	7.5 Hour(9inch DVR); 4 Hour(13.3inch DVR)		
	Charge Time	7 Hour		
	Waterproof	P66 (Whole machine is waterproof only when the control box is closed and camera fully installed)		
	MEA S.	PICS1XXX: 445*385*355mm; PICS2XXX: 540*430*365mm;		
	Weight	PICS1XXX Approx 9Kg; PICS2XXX: Approx 13Kg (slight different from different length of cable)	PICS1XXX: Approx 8.5Kg; PICS2XXX: Approx 12Kg (slight different from different length of cable)	
<b>Camera</b>	Sensor	1/3" CMOS	1/4" CMOS	
	TV-Line	1080P (1920*1080)	720P (1280*720)	
	View Angle	120°	90°	
	Focus Distance	15cm (approx)	5cm (approx)	
	Depth Of Field	100cm(approx)	100cm(approx)	
	Camera Size	Φ21mm×45mm (Main body)	Φ12.8mm×12mm (Main body)	
	Camera Length	165mm	135mm	
	Front Lens	Sapphire		
	Shell Material	304#Stainless Steel		
	Lighting	Built-in 12×LED (White)	Built-in 6×LED (White)	
	LED Driver	Built-in Dimmer(Pulley button)		
	Water-resistant	20m water (Camera fix on Cable)		
	<b>DVR</b>	Screen	IPS 16:9 super bright high-definition color LCD screen	
		Resolution	9inch DVR: 1024(RGB)×600; 13.3inch DVR: 1920(RGB)×1080	
		Mirror and Flip	9inch DVR: Support image mirror, Flip, Mirror & Flip; 13.3inch DVR: None	
Video Resolution		1920×1080	1280×720	
Video Encoding		H.264		
Photograph		1920×1080	1280×720	
Audio Recording		Local Sound		
Out Put		TV and Audio output		
External Memory		Support MAX. 1TB SD Card or USB storage device		
Play Back		Photo and Video with Audio		
Language		English, Chinese		
Keyboard Compatibility		Support Specific PC Wireless Keyboard		
Typing Language		English		
Precision of Meter		Counter ±0.5%		
Meter and Feet Switch		Support		
	Support			
<b>Cable</b>	Cable Diameter	Φ5.3mm/6.8mm	Φ4.8mm/5.3mm	
	Cable Color	Red	Φ4.8mm blue /5.3mm red	
	Cable Length	PICS1XXX: 10/20/ 30meter (5.3mm cable only); PICS2XXX: 20/30/40/50M	PICS1XXX 10/20/ 30meter (5.3mm cable); 10/20/ 30/40meter (4.8mm cable); PICS2XXX: 20/30/40/50M	
	Meter Counter	Standard		
<b>Control Box</b>	Size	361*262*157mm		
	Box Color	Black+Red		



## INSTALLATION

### Install cable reel to metal frame

Put the cable reel into the middle of the metal frame, align the 4 screw slots and fasten by 4 pairs of screws and nuts ①.

### Install camera head

Pull out the fiberglass cable with connector through the hook ② and screw in camera head ③, then put the camera head in the camera holder ④. Plug one end of the connection cable to the camera port ⑤ in the reel and fasten the screw.



### Install control box

Before install control box, settle the connection cable to the cable clip ⑥ on the plastic button placement to make it tidy. Place the control box on the plastic button placement ⑦ with the control box handle and metal frame handle in the same direction, then push forward the control box gently until there is a sound to indicate that the control box is automatically locked by the padlock ⑧. Plug the other end of the connection cable to the camera port ⑨ in the control box and fasten the screw. Take out the pothooks and put into the pothook holder ⑩, wind the connection cable around the pothooks to make it tidy.

### Uninstall control box

Use one finger to press the padlock to the bottom, while using the other hand to hold the handle of the control box and pull gently until the control box is loose to take out.



Uninstall ← Pull

Install → Push

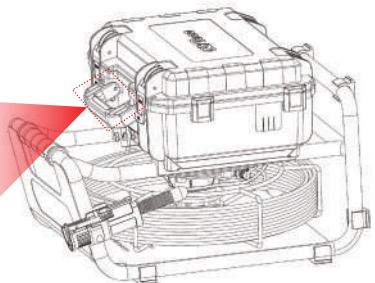
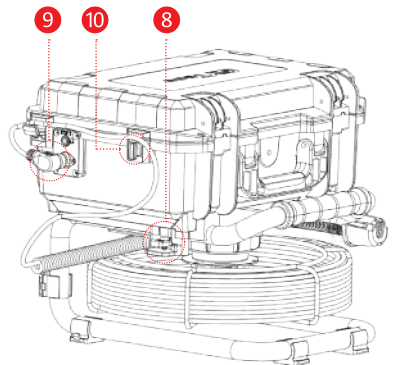
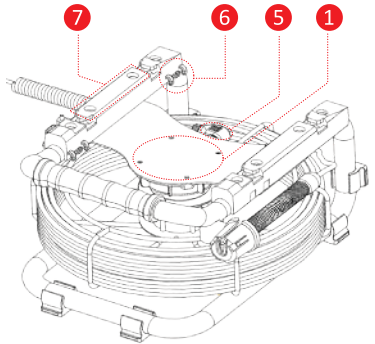
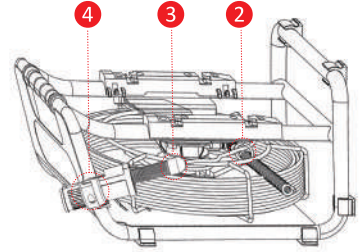

## Install camera brackets

Camera brackets are designed to support the camera and keep it in the middle of the pipe. There are 2 kinds of brackets for 21mm camera head, 1 bracket for 12.8mm camera head. Choose bracket properly per application requirement.

46mm bracket  
For 2.5"-3.5" pipes

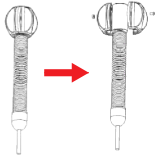

78mm bracket  
For 4"- 8" pipes

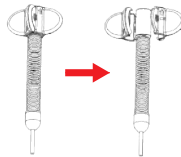

25mm bracket  
For 1.5"- 2" pipes

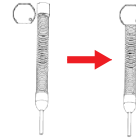

Sleeve the camera head with 46/78mm bracket, then fasten each pairs of screws and nuts by screwdriver.

Sleeve the camera head with 25mm bracket, then fasten screw by screwdriver.

## BASIC OPERATION

### Charge the device

Before you use the device for the first time, please make sure the power is fully charged. Plug the 12V power supply or car charger into the power charge port in the control box to charge, the power indicators will illuminate red to show in charging status, and it will turn off when the power is fully charged. A full charge will be taken about 7hours.

*Notice: You must use the original power supply or car charger provided by the vendor.*

### Install SD card/USB storage device

To insert the SD card(MAX.1TB) into the SD card slot, use your thumb and index finger to carry the SD card and insert into the SD card slot, then use your thumb to push gently until the SD card is locked with a sound. To take out the SD card, push the end of the SD card with your thumb, the SD card is unlocked and pop-up, then you can pull out the SD card. To insert USB storage device, insert the right direction of the USB socket into the USB slot to reach the bottom.

*Notice:*

1. Please insert the SD card/USB storage device before power on the device.
2. The device can only identify one memory storage at a time, so just choose SD card or USB storage device before you work. If you insert both, the system default to choose SD card.
3. If you insert the USB storage device with length more than 22mm, please remember to take it out before you close the control box to avoid damage on the USB storage device and the USB slot.

### Install wireless keyboard

Take out the wireless keyboard and flip to the back, remove the battery cover, install correctly 2XAAA batteries, reinstall the battery cover, flip the ON/OFF swift to ON to power on, then reinstall the wireless keyboard back to the control box.

## OPERATING INSTRUCTION

### Safety Precautions:

1. Please always wear protective gloves to operate the camera unit for safety reasons. Properly positioning the cable reel will save time and strength to push out/in the pipeline, while to minimize the rate of equipment damage.
2. When pushing the camera in the pipe, the end of your stroke should be as close to the entry as possible, but DO NOT CONTINUE TO PUSH WHEN YOUR HANDS CATCH THE CABLE ON THE ENDFE OF AN ENTRY TO PREVENT YOUR HANDS STABBED. Standing too far back with an excess of cable between your hands and the entry may cause the cable to fold on itself outside the entry and damage the cable.
3. Try to keep the push cable away from sharp edge of a pipe entry because this may cause damage. If the camera does not seem to go any farther, DO NOT FORCE TO PUSH THE CAMERA! Try another entry if possible.
4. The larger the cable diameter, the greater the elasticity. PLEASE BE MORE CAREFUL WHEN YOU OPERATION THE CAMERA UNIT WITH 6.8MM FIBERGLASS ROD TO PREVENT THE CABLE REEL POP OUT AUTOMATICALLY TO GET HURT YOURSELF AND THE PEOPLE/OBJECTS AROUND.
5. Always try to inspect the pipe with the same direction of water flow, this will keep the camera clean, and allow you to push noticeably farther with less friction. If the water is preventing you from seeing an area of importance, stop and temporarily turn it off.
6. Always try to push the push cable through the pipeline steadily and slowly, with a short distance entry per time, keep the hands at the pipeline entrance, so that can control the push cable and prevent it stuck, bent or scratch.
7. When inspecting a pipe with changes in direction such as P-traps,S-traps, Tee's, Y's, crossovers, elbows, ect, it is necessary to give a little extra pushing force to go through the changes. Pull back the camera head about 20cm/ 8" from the bend and give it a quick push (if necessary) to pop-up the camera to go through the turn rapidly by using the minimal force.
8. Make sure the sapphire cover is clean enough before inspecting. A slight film of detergent on the sapphire cover may minimize the possibility of grease sticking to the cover. If necessary, take advantage of any standing water in the pipe to wash the camera head by jiggling it in the water.
9. As the materials of pipe are vary, it will be necessary to adjust the lighting settings to maximize picture quality when you place the camera head into the pipe.
10. The camera can go through multiple 45 and 90 degree bends and wyes, but do not try to force it to go through a P-trap or Tee if there is a large amount of resistance.
11. Do not attempt to remove or store push cable on the reel solely by turning the reel itself. You can manually pull or push the cable from the reel and wind or unwind it.
12. Camera with LED lights on stay in the pipe or confined space will be easy to generate heat, this may cause the fuzzy lines to appear on the monitor. In this situation, please turn off the system, take out the camera from the pipe or confined space for 10-15minuts so as to cooling the camera head. Running water into the pipe may also help to cool the camera head. Always use the minimize illumination required to maximize picture quality and avoid excessive heat generated to protect the camera head.
13. When you finish your inspection work, or take a prolonged break during working, turn off the system for power saving.
14. Operating environment:
  - (1) The camera system operating temperature is between -10°C ~ 50°C (14°F~ 122°F). It is normal for the operating time to be shortened when the temperature is low.

- (2) Storage at too high or low temperatures will also result in a gradual battery capacity loss. As a result, the operating time of your inspection system may be considerably reduced.
- (3) It is normal for the camera system to become warm during operation, because the inspection system casing can conduct heat.

### 1. Preparation

Place the system in a flat place, open the control box, adjust the sunshade to the appropriate position.

### 2. Power on the device



Press and hold the **Power button**  on the control board for 3 second to power on the unit and illuminate the LCD. The power indicators beside the power button and out of the control box will turn green, the battery capacity indicator will light up to show the battery capacity (When the battery meter showed one bar of power left and flickering, it indicates that the battery is low and needs to be charged as soon as possible). When illuminating the LCD, the Screen will show on "NO SIGNAL" with blue background for 5 seconds and "WELCOME" for another 5 seconds with white background, then enter the real-time image. The lower the battery, the longer it takes. After entering the system, the date and time is shown on the upper left corner, the storage icon and capacity information is shown on the upper right corner.

### 3. Camera inspection operating

Take out the camera from the camera holder, one hand to hold and control the reel speed, the other hand to point the camera head at the target entrance of the pipe, slowly pushing forward. When retrieve the push cable, one hand to pull out the cable slowly, the other hand to take up the cable backward to prevent being stacked and intertwined.











When storing the push cable, hands should be close to the cable reel and push the cable with a short length every time. Push a long distance can cause the push cable bend or broken.

### 4. Meter counter operating

When you pull out the cable with the reel rotating, the meter counter will begin to work and the meter data will be shown on the lower right corner. You can switch the meter unit from meter to feet by pressing the **Meter-Feet switch button** , or start to measure the meter from 0 at a certain distance by pressing the **Reset button** .

*Notice: (1) To decrease the deviation of the meter counter, turn on the system before you pull out the push cable from the cable reel. (2) The deviation of meter counter will be increased if the total length of cable is changed more than 3meters, you need to change the default perimeter value to decrease the deviation.*

### 5. Photo and video operating

Press the **Camera button**  to take a picture, a camera icon will be shown in the middle of the display to indicate the capture is successful and stored. Press the **Video button** or **OK button**   to start recording a video, a red recording icon with recording time will be shown on the lower left corner to indicate the recording status. In recording status, press the **Video/OK button**   to pause the recording, press again to continue recording; press the **Camera button**  to capture a picture; press the **Audio button**  to turn on the audio recording, press again to turn off; press the **Up button/Down button**   to zoom in and zoom out; press the **Stop button**  to stop the recording.

## 6. Wireless keyboard operating

The receiver is default installed in the control board and paired with the wireless keyboard. Press the blank key (or the other keys available) to display the >\_ on the image, the white cursor flashing, you can begin to type 48 characters each line and 15lines in total in an image.

*Notice:*





(1) Not all the keys on the keyboard are available to use in this system, but it doesn't affect you to input the English characters including letters, numbers and symbols, special keys set with special functions: F5: Prohibit input; ESC: Release the prohibit input; F7: Clear all input characters on the display.

(2) Both picture and video can be input text and saved with the picture and video.

(3) When the battery indicator on the wireless keyboard is flashing, it indicates that the low power, please replace the battery in time, otherwise the keyboard will stop working or can't type characters properly.

(4) When you change a new keyboard, please change the receiver together.

## 7. Playback videos/pictures

Press the **Menu button**  on the control board to enter MAIN MENU, then select PLAY AVI and press OK button to enter the VIDEO PLAYBACK status. Press **Up/Down button** to move up or down to select the target file, press the **Right/Left button**   to page down and page up. Once select the target file, press **OK/Video button** to play video, press the **Camera button** to pause play, press again to continue playing; press the Stop button to finish the play; press the **ESC button**  to quit playing and return the previous interface. In playing video status, press the **Up/Down button** to enlarge/ decrease the volume; press the **Right/Left button** to speed up/down the video playback speed (Rate at X2, X4, X8, X16, X32).

In MAIN MENU status, select PLAY JPEG and enter the PICUTRE PLAYBACK status. Select the target picture to playback.

## 8. Deletion operating

To delete the video/picture, you can only delete the file in the single file listed by pressing the Stop button. It will pop up a prompt "Do you want to delete this file?", you can choose "NO" to cancel the deletion, or "YES" to confirm the deletion.

## 9. System setup

In MAIN MENU status, select SYSTEM SETUP to enter the MAIN setting interface. Follow the flow chat to setup the language, date/time, date format, display resolution, videosystem/length/quality, perimeter, disk format, upgrade system and system restart.

*Notice: The perimeter is set according to the total length and diameter of push cable and the diameter of the reel, please don't change the default value to reduce the error rate of the meter counter unless you changed the above elements.*

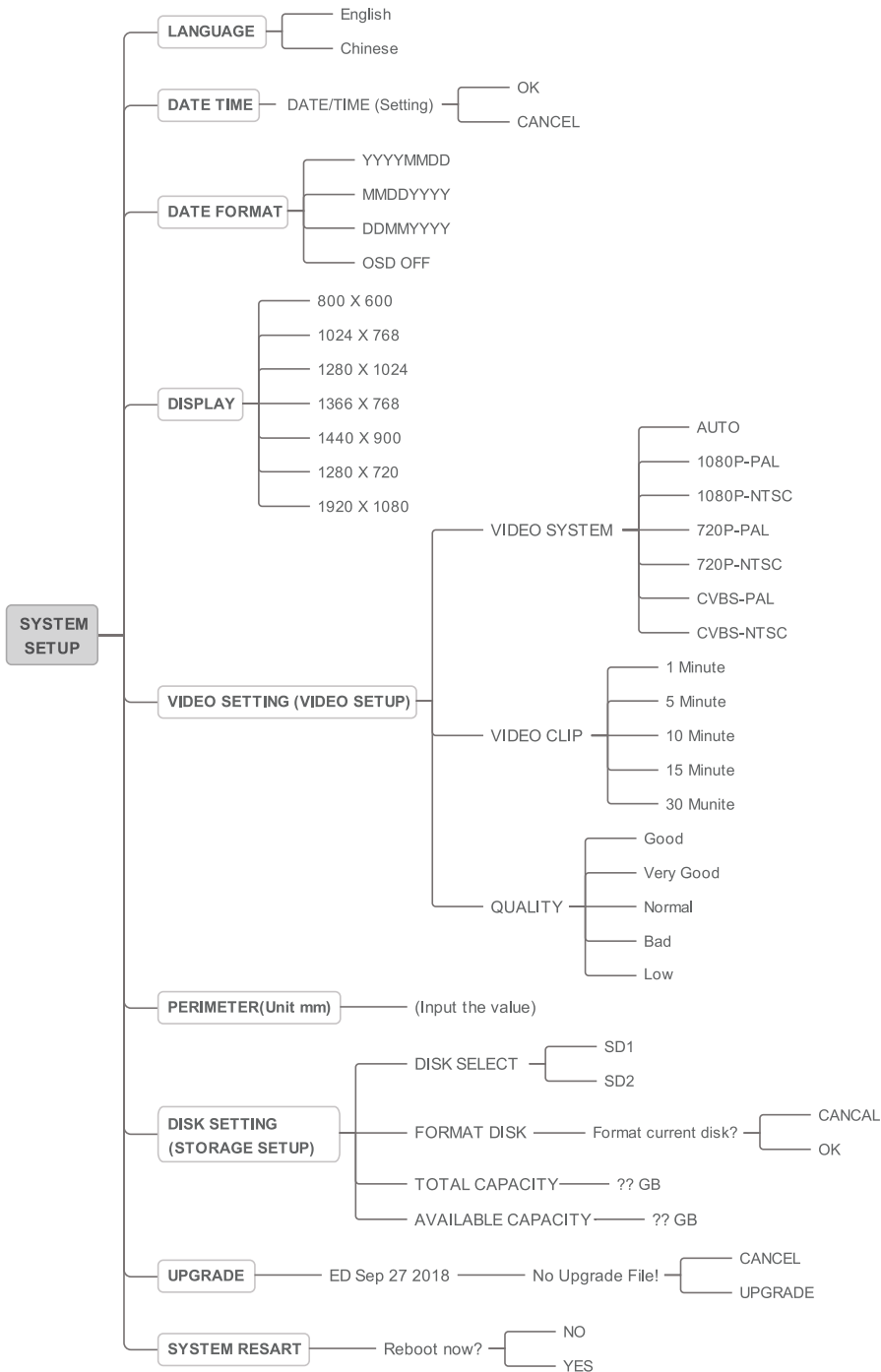

## 10. Display setup operating

Press **Menu button**  on the display control board to enter the display settings. Press **Up/Down button**   to select the setting; press the **Menu button** to confirm the selection; press **Flip button**  to flip the screen (9inch display)/Press **ESC button**  to exit the setting and return to last interface (13.3inch display), press **Power button**  to power on/off the display only.

### For 9 inch display settings:

- (1) BRIGHTNESS: 0-100
- (2) CONTRACT: 0-100
- (3) COLOR: 0-100
- (4) HPOSITION: 0-100
- (5) VPOSITION: 0-100
- (6) AUTO: (Choose auto stting)
- (7) ZOOM: 16:9 (default), 4:3
- (8) DOWN: RD, RN, RU,LD
- (9) LANGUAGE: ENGLISH, 日文, 繁體中文, 简体中文, YCCK., ENGELS, ITALIANO, PORTUG., ENSPAÑOL, FRANCO., DEUTSCH
- (10) RESET
- (11) VER: AGA-7DH

### For 13.3 inch display settings:

- (1) BRIGHTNESS  
BRIGHTNESS: 0-100  
CONTRACT: 0-100  
ECO: STANDAND, TEXT, GAME, MOVIE  
DCR: OFF, ON
- (2) IMAGE  
H. POSITION: 0-100  
V. POSITION: 0-100  
CLOCK: 0-100  
PHASE: 0-100  
ASPECT: WIDE, 4:3
- (3) COLOR TEMP.  
COLOR TEMP.: USER (setting by user) , COOL, WARM  
RED: 0-100  
GREEN: 0-100  
BLUE: 0-100

(4) OSD SETTING

LANGUAGE: ENGLISH, FRANÇAIS, DEUTSCH, 简体中文, ITALIANO, ESPAÑOL, PORTUGUÊS, TURKCE, POLSKI, NEDERLANDS, 日本語.

OSD H.POS.: 0-100

OSD V. POS.: 0-100

OSD TIMER: 0-100

TRANSPARENCY: 0-100

(5) RESET



IMAGE AUTO ADJUST, COLOR AUTO ADJUST, RESET

(6) MISC.

SIGNAL SOURCE: VGA, HDMI (disabled)

VOLUME: (disabled)

**11. 2.4G monitor operating (optional function)**

If your system supports 2.4G monitor, install the antenna first to get better signal (The antenna port is outside the control box on the left.). Press **2.4G button**  to turn on 2.4G function, the indicator beside it will turn green. Press the Channel **switch button**  to pair with the monitor. (There are 2 channels for options.)

For the operation on the monitor, please refer to the User Manual of 5" TFT VIDEO MONITOR.

**12. 512Hz transmitter (optional function)**

When using the 512Hz receiver to search the camera with 512Hz transmitter, set the sensitivity according to the distance, the closer to the camera head, the lower sensitivity. The deviation is about 10CM.

512Hz Transmitter	Frequency	512±2Hz
	Transmit Mode	Constant
	Transmission Distance	Up to 7 meters in open area

**13. End of work**

When ending the inspection work, press the **Power button** on control board for 3 seconds to turn off the system and close the sunshade before closing the control box.



**TROUBLESHOOTING**

<b>Problems</b>	<b>Possible Causes</b>	<b>Likely Solutions</b>
No Image	Cable connection is faulty or loose	Check the cable connection, clean and reconnect if necessary
	Camera connector soiled	Clean the camera connector
	Wrong SD card/USB storage device	Turn off the system and replace the SD card/USB storage device
	Wrong setting	Enter the setup menu and select reset
DVR can not boot	No Power	Recharge/Press the power button on display control board
	Display power connection is faulty or loose	Check the display power connection, reconnect if necessary
Can not input characters	The wireless keyboard is not powered	Install correctly the 2AAA batteries and switch the power button to ON
	The wireless keyboard is low battery	Change the batteries
	Wireless keyboard or receiver fault	Check the keyboard and receiver on a PC
Meter counter is not accurate	Knurled wheel slip	Fit push cable into the guide slot and hook
	Not set to zero	Press reset button to set zero
	Pull out the push cable before power on the system	Power on the system before pulling out the push cable from the cable reel
	The length of the push cable is changed	Rewrite the perimeter value
Can play some AVI videos	These AVI videos are not recorded by the system	Play them on other device supported, this system only support to play the video recorded by itself

## MAINTENANCE TIPS

1. If you don't use this system for a long time, please charge it every 6 months to ensure the battery in normal working status.
2. To avoid unclear images, be sure to clean the inspection system lens before taking pictures or recording videos. Use a lens brush or soft cloth to clean the lens.
3. Before initial use of a memory device, it is recommended to use the system to format first so as to make it more conducive to the system.
4. Do not force the misplaced SD card/USB storage device into the SD card/USB slot, and do not force to pull out the SD card from the slot directly.

## WARRANTY INFORMATION

We warrant its instruments and accessories against defects in material or workmanship for one year from the date of purchase. We will replace or repair the defective unit, at its option, subject to verification of the defect.

The warranty becomes void if any physical damage is present or if the system is disassembled by the user. Warranty is void if damage or system failure occurred due to outside factors such as collision, fire, flood, dirt, sewage, earthquake, and other force majeure events as well as incorrect usage of electricity or use of non-original accessories. It is the sole responsibility of the user if problems (such as data loss and system failure) occurred due to non-factory installed software, parts, and/or non-original accessories.

This warranty does not apply to defects resulting from abuse, neglect, accident, unauthorized repair, alteration, or unreasonable use of the product.

Any implied warranties arising from the sale of a product, including but not limited to implied warranties of merchantability and fitness for a particular purpose, are limited to the above. We shall not be liable for loss of use of the product or other incidental or consequential damages, expenses, or economic loss, or for any claim of such damage, expenses, or economic loss.

State laws vary. The above limitations or exclusions may not apply to you.

## RETURN FOR REPAIR POLICY

Every effort has been made to provide you with a reliable product of superior quality. However, in the event your instrument requires repair, please contact our Sales to obtain an Return Goods Authorization number before forwarding the unit via prepaid to us.

***All the graphics and specifications included in this user manual are subject to minor change without prior notice.***