

# PRESYS®



## Universal Process Calibrator MCS-12-IS

TECHNICAL MANUAL

## IMPORTANT INSTRUCTIONS:

- This manual contains instructions for the MCS-12-IS (in the rest of the manual called by calibrator) designed for use in hazardous areas. Read the entire manual before using the calibrator.
- Before using the calibrator, carefully read the section “Special conditions for safe use”.
- Keep the calibrator in a dry environment whenever possible.
- In case of failure or suspected failure, especially in safe operation, send the instrument for repair to the factory., always send the instrument to the factory for repair.
- When not in daily use, before starting up, let the calibrator be turned on for at least one hour.

The warranty conditions are available on our website:  
**[www.presys.com.br/warranty](http://www.presys.com.br/warranty)**

## Table Of Contents

Marking details.....	3
Special conditions for safe use.....	4
1 - Introduction.....	5
1.1. General Description.....	5
1.2. Specifications – Inputs.....	6
1.3. Specifications – Outputs.....	9
2 - Operation.....	14
2.1. Parts Identification.....	14
2.2. Battery and charger.....	17
2.3. Using Calibrator: Basic Functions.....	17
2.4. Measurement or input functions.....	20
2.5. Generation or Output Functions.....	28
2.6. Available power supplies.....	32
2.7. Calibration examples.....	33
2.8. Special Programming.....	35
2.8.1. FILTER Programming.....	35
2.8.2. DECIMAL Programming.....	35
2.8.3. Probe.....	36
2.8.4. STEP Programming.....	37
2.8.5. RAMP Programming.....	38
2.9. Special Functions.....	39
2.9.1. SCALE Function.....	40
2.9.2. CAL Function.....	41
2.9.3. SCALE Function.....	44
2.9.4. CONV Function.....	46

2.10. MEM Command.....	47
2.11. Warning Messages .....	48
3 - Adjustment .....	49
3.1. Input adjustment (IN).....	50
3.2. Output adjustment (OUT).....	52
Notes.....	56

PREPARE

## MCS-12-IS Marking details

Certificate number .....	<b>NCC 12.1094X</b>
Equipment Model .....	<b>MCS-12-IS</b>
Manufacturer .....	<b>PRESYS Instrumentos e Sistemas Ltda.</b> R. Luiz da Costa Ramos, 260 - Saude - Sao Paulo - SP - Brazil Zip 04157-020 Phone: +55 11 3056.1900 Fax: +55 11 5073.3366 www.presys.com.br - vendas@presys.com.br
Marking .....	<b>Ex ia IIC T4 Ga</b>
<b>Protection Type</b> Intrinsically Safe	
<b>Equipment Group</b> Explosive gas atmospheres, Groups IIC, IIB and IIA	
<b>Temperature Class</b> Maximum surface temperature of 135 °C	
<b>Equipment Protection Level</b> Very high use in zones 0, 1 and 2	

**Note:** The Ex Compliance Certificate is sent with the instrument and its accessories.

## Special conditions for safe use

- Use the calibrator only as described in this technical manual.
- The battery should only be charged in a safe area, using the charger provided. To avoid explosion or fire, use only the battery (BT12-IS) and charger (CG12-IS) specified by Presys.
- Never replace the battery in a hazardous area.
- Do not use the serial communication port in an explosive atmosphere.
- The calibrator's aluminum metallic enclosure is protected by a leather case (BC12-IS) that should always house it when in a hazardous area.
- The intrinsic safety of the instrument is only valid for the connections shown in this manual, respecting the intrinsically safe input and output parameters. The entity parameters and connections are illustrated in items 2.4, 2.5 and 2.6 - Operation.
- To avoid damage to the instrument and invalidate the Ex certification, never apply a voltage greater than 30 V between the terminals and the metallic enclosure of the instrument.
- Never open the calibrator. Opening the enclosure may void the calibrator Ex certification.
- Do not use tools on the calibrator that may cause sparks; this practice can cause an explosion.
- Never perform maintenance on the calibrator; the components used are specified and cannot be changed.
- Never use the calibrator in an area close to explosive dust.

## **1 - Introduction**

### **1.1. General Description**

MCS-12-IS is a universal process calibrator designed to be used in hazardous areas where explosive or flammable vapors are present. Enables the measurement and generation of signals used in Instrumentation and Process Control. It is designed to provide the necessary resources in order to facilitate the work of keeping the instruments of the process adjusted and calibrated. It has high levels of accuracy, including aspects related to changes in ambient temperature and the maintenance of specifications over long periods of time. Its construction takes into account the field use, thus including items of great value such as: bag with straps to fasten on the belt or on the shoulder allowing freedom for the hands, liquid crystal display with high contrast facilitating visibility in low light environments, rechargeable battery and large memory capacity to store the values obtained, making it possible to transfer them to the microcomputer, when necessary. In addition to these, several construction factors that add quality and efficiency to MCS-12-IS can be mentioned.

It incorporates the most modern concepts of union of adjustments and calibrations with information technology, where data are shared both by the instrument and by the computer, giving efficiency to the treatment of information, in the form of issuing reports and certificates, the automated management of tasks and the organization and archiving of data, that is, it covers an entire context aimed at complying with quality procedures, mainly related to the ISO-9000 standard.

## 1.2. Specifications – Inputs

Input Ranges	Resolution	Accuracy	Remarks
<b>millivolt</b> -150 to 150 mV 150 to 2050 mV	0.001 mV 0.01 mV	$\pm 0.01\%$ FS* $\pm 0.02\%$ FS	$R_{\text{input}} > 10\text{ M}\Omega$ auto-ranging
<b>volt</b> -0.5 to 11 V 11 to 30 V	0.0001 V 0.0001 V	$\pm 0.02\%$ FS $\pm 0.02\%$ FS	$R_{\text{input}} > 1\text{ M}\Omega$
<b>mA</b> -5 to 24.5 mA	0.0001 mA	$\pm 0.02\%$ FS	$R_{\text{input}} < 100\ \Omega$
<b>Resistance</b> 0 to 400 $\Omega$ 400 to 2050 $\Omega$	0.01 $\Omega$ 0.01 $\Omega$	$\pm 0.02\%$ FS $\pm 0.03\%$ FS	Excitation current 0.31 mA, auto-ranging
<b>frequency **</b> 0 to 600 Hz 600 to 1300 Hz 1300 to 10000 Hz	0.01 Hz 0.1 Hz 1 Hz	$\pm 0.02\text{ Hz}$ $\pm 0.2\text{ Hz}$ $\pm 2\text{ Hz}$	$R_{\text{input}} > 50\text{ k}\Omega$ Voltage DC <sub>max</sub> = 30 V AC Signal from 1.5 to 30 V
<b>counter**</b> 0 to $10^8$ - 1 count	1 count	_____	The same remark as frequency Pulses Frequency < 9000 Hz

(\*) FS = Full Scale

(\*\*) Accuracy valid since the output frequency is not configured.



Input Ranges	Resolution	Accuracy	Remarks
<b>Pt-100</b> -200 to 850 °C / -328 to 1562 °F	0.01 °C / 0.01 °F	± 0.2 °C / ± 0.4 °F	IEC-60751
<b>Pt-1000</b> -200 to 280 °C / -328 to 1562 °F	0.1 °C / 0.1 °F	± 0.2 °C / ± 0.4 °F	IEC-60751
<b>Cu-10</b> -200 to 260 °C / -328 to 500 °F	0.1 °C / 0.1 °F	± 4.0 °C / ± 8.0 °F	Minco 16-9
<b>Ni-100</b> -60 to 250 °C / -76 to 482 °F	0.1 °C / 0.1 °F	± 0.4 °C / ± 0.8 °F	DIN-43760
<b>probe*</b> -200 to 850 °C / -328 to 1562 °F	0.01 °C / 0.01 °F	± 0.1 °C / ± 0.2 °F	IEC 60751
<b>TC-J</b> -210 to 1200 °C / -346 to 2192 °F	0.1 °C / 0.1 °F	± 0.2 °C / ± 0.4 °F	IEC-60584
<b>TC-K</b> -270 to -150 °C / -454 to -238 °F	0.1 °C / 0.1 °F	± 0.5 °C / ± 1.0 °F	IEC-60584
-150 to 1370 °C / -238 to 2498 °F	0.1 °C / 0.1 °F	± 0.2 °C / ± 0.4 °F	
<b>TC-T</b> -260 to -200 °C / -436 to -328 °F	0.1 °C / 0.1 °F	± 0.6 °C / ± 1.2 °F	IEC-60584
-200 to -75 °C / -328 to -103 °F	0.1 °C / 0.1 °F	± 0.4 °C / ± 0.8 °F	
-75 to 400 °C / -103 to 752 °F	0.1 °C / 0.1 °F	± 0.2 °C / ± 0.4 °F	

(\*) Probe is an independent input for a reference RTD in order to use as standard thermometer. The accuracy is related only to calibrator input.

Input Ranges	Resolution	Accuracy	Remarks
<b>TC-B</b> 50 to 250 °C / 122 to 482 °F 250 to 500 °C / 482 to 932 °F 500 to 1200 °C / 932 to 2192 °F 1200 to 1820 °C / 2192 to 3308 °F	0.1 °C / 0.1 °F 0.1 °C / 0.1 °F 0.1 °C / 0.1 °F 0.1 °C / 0.1 °F	± 2.5 °C / ± 5.0 °F ± 1.5 °C / ± 3.0 °F ± 1.0 °C / ± 2.0 °F ± 0.7 °C / ± 1.4 °F	IEC-60584
<b>TC-R</b> -50 to 300 °C / -58 to 572 °F 300 to 1760 °C / 572 to 3200 °F	0.1 °C / 0.1 °F 0.1 °C / 0.1 °F	± 1.0° C / ± 2.0 °F ± 0.7° C / ± 1.4 °F	IEC-60584
<b>TC-S</b> -50 to 300 °C / -58 to 572 °F 300 to 1760 °C / 572 to 3200 °F	0.1 °C / 0.1 °F 0.1 °C / 0.1 °F	± 1.0° C / ± 2.0 °F ± 0.7° C / ± 1.4 °F	IEC-60584
<b>TC-E</b> -270 to -150 °C / -454 to -238 °F -150 to 1000 °C / -238 to 1832 °F	0.1 °C / 0.1 °F 0.1 °C / 0.1 °F	± 0.3 °C / ± 0.6 °F ± 0.1 °C / ± 0.2 °F	IEC-60584
<b>TC-N</b> -260 to -200 °C / -436 to -328 °F -200 to -20 °C / -328 to -4 °F -20 to 1300 °C / -4 to 2372 °F	0.1 °C / 0.1 °F 0.1 °C / 0.1 °F 0.1 °C / 0.1 °F	± 1.0 °C / ± 2.0 °F ± 0.4 °C / ± 0.8 °F ± 0.2 °C / ± 0.4 °F	IEC-60584
<b>TC-L</b> -200 to 900 °C / -328 to 1652 °F	0.1 °C / 0.1 °F	± 0.2 °C / ± 0.4 °F	DIN-43710
<b>TC-C</b> 0 to 1500 °C / 32 to 2732 °F 1500 to 2320 °C / 2732 to 4208 °F	0.1 °C / 0.1 °F 0.1 °C / 0.1 °F	± 0.5 °C / ± 1.0 °F ± 0.7 °C / ± 1.4 °F	W5Re / W26Re W5Re / W26Re

### 1.3. Specifications – Outputs

	<b>Output Ranges</b>	<b>Resolution</b>	<b>Accuracy</b>	<b>Remarks</b>
<b>millivolt</b>	-10 to 110 mV	0.001 mV	$\pm 0.02\%$ FS	$R_{out} < 0.3 \Omega$
<b>volt</b>	0 to 12 V	0.0001 V	$\pm 0.02\%$ FS	$R_{out} < 0.3 \Omega$
<b>mA</b>	0 to 22 mA	0.0001 mA	$\pm 0.02\%$ FS	$R_{max} = 450 \Omega$
<b>Resistance</b>	0 to 400 $\Omega$	0.01 $\Omega$	$\pm 0.02\%$ FS	For external excitation current of 1.0 mA
	400 to 2500 $\Omega$	0.1 $\Omega$	$\pm 0.03\%$ FS	
<b>frequency</b>	0 to 100 Hz	0.01 Hz	$\pm 0.02$ Hz	Peak value: 12 V / 25 mA max.
	0 to 10000 Hz	1 Hz	$\pm 2$ Hz	
<b>pulse</b>	0 to $10^8$ - 1 pulse	1 pulse	—————	Peak value: 22 V / 25 mA max. Pulses frequency up to 10000 Hz
<b>Pt-100</b>	-200 to 850 °C / -328 to 1562 °F	0.01 °C / 0.01 °F	$\pm 0.2$ °C / 0.4 °F	IEC-60751
<b>Pt-1000</b>	-200 to 400 °C / -328 to 752 °F	0.1 °C / 0.1 °F	$\pm 0.1$ °C / 0.2 °F	IEC-60751
<b>Cu-10</b>	-200 to 260 °C / -328 to 500 °F	0.1 °C / 0.1 °F	$\pm 2.0$ °C / 4.0 °F	Minco 16-9
<b>Ni-100</b>	-60 to 250 °C / -76 to 482 °F	0.1 °C / 0.1 °F	$\pm 0.2$ °C / 0.4 °F	DIN-43760

Output Ranges	Resolution	Accuracy	Remarks
<b>TC-J</b> -210 to 1200 °C / -346 to 2192 °F	0.1 °C / 0.1 °F	± 0.4 °C / 0.8 °F	IEC-60584
<b>TC-K</b> -270 to -150 °C / -454 to -238 °F -150 to 1370 °C / -238 to 2498 °F	0.1 °C / 0.1 °F 0.1 °C / 0.1 °F	± 1.0 °C / 2.0 °F ± 0.4 °C / 0.8 °F	IEC-60584
<b>TC-T</b> -260 to -200 °C / -436 to -328 °F -200 to -75 °C / -328 to -103 °F -75 to 400 °C / -103 to 752 °F	0.1 °C / 0.1 °F 0.1 °C / 0.1 °F 0.1 °C / 0.1 °F	± 1.2 °C / 2.4 °F ± 0.8 °C / 1.6 °F ± 0.4 °C / 0.8 °F	IEC-60584
<b>TC-B</b> 50 to 250 °C / 122 to 482 °F 250 to 500 °C / 482 to 932 °F 500 to 1200 °C / 932 to 2192 °F 1200 to 1820 °C / 2192 to 3308 °F	0.1 °C / 0.1 °F 0.1 °C / 0.1 °F 0.1 °C / 0.1 °F 0.1 °C / 0.1 °F	± 5.0 °C / 10.0 °F ± 3.0 °C / 6.0 °F ± 2.0 °C / 4.0 °F ± 1.4 °C / 2.8 °F	IEC-60584

Output Ranges	Resolution	Accuracy	Remarks
<b>TC-R</b> -50 to 300 °C / -58 to 572 °F 300 to 1760 °C / 572 to 3200 °F	0.1 °C / 0.1 °F 0.1 °C / 0.1 °F	± 2.0 °C / 4.0 °F ± 1.4 °C / 2.8 °F	IEC-60584
<b>TC-S</b> -50 to 300 °C / -58 to 572 °F 300 to 1760 °C / 572 to 3200 °F	0.1 °C / 0.1 °F 0.1 °C / 0.1 °F	± 2.0 °C / 4.0 °F ± 1.4 °C / 2.8 °F	IEC-60584
<b>TC-E</b> -270 to -150 °C / -454 to -238 °F -150 to 1000 °C / -238 to 1832 °F	0.1 °C / 0.1 °F 0.1 °C / 0.1 °F	± 0.6 °C / 1.2 °F ± 0.2 °C / 0.4 °F	IEC-60584
<b>TC-N</b> -260 to -200 °C / -436 to -328 °F -200 to -20 °C / -328 to -4 °F -20 to 1300 °C / -4 to 2372 °F	0.1 °C / 0.1 °F 0.1 °C / 0.1 °F 0.1 °C / 0.1 °F	± 2.0 °C / 4.0 °F ± 0.8 °C / 1.6 °F ± 0.4 °C / 0.8 °F	IEC-60584
<b>TC-L</b> -200 to 900 °C / -328 to 1652 °F	0.1 °C / 0.1 °F	± 0.4 °C / 0.8 °F	DIN-43710
<b>TC-C</b> 0 to 1500 °C / 32 to 2732 °F 1500 to 2320 °C / 2732 to 4208 °F	0.1 °C / 0.1 °F 0.1 °C / 0.1 °F	± 0.5 °C / 1.0 °F ± 0.7 °C / 1.4 °F	W5Re / W26Re W5Re / W26Re

Accuracy values are valid within a year and temperature range of 20 to 26 °C. Outside these limits add 0.001 % FS / °C taking 23 °C as the reference temperature. For thermocouples, using the internal cold junction compensation add a cold junction compensation error of ± 0.2 °C or ± 0.4 °F max.

## Probe

Independent input for RTD (**Probe**). Probe is a high accuracy 4-wire Pt100 available under previous consult.

For a higher level of accuracy, it is possible to configure the parameters of the sensor *Callendar-Van Dusen* curve in the MCS-12-IS, correcting the errors found in the sensor certificate (see section 3.8.3 - Probe).

## Software Special Functions

### - Any output programmable in:

- 1) **STEP**: 10%, 20%, 25% or up to 11 programmable setpoints via key or adjustable time.
- 2) **RAMP**: up and down with programmable travel and dwell time.

### - Special functions:

- 1) **SCALE**: makes the scaling of both input and output in 6 digits and allows the configuration of decimal point.
- 2) **CAL**: scales the input in same unit of output.
- 3) **CONV**: converts any input into any output, galvanically isolated.

- **MEM command**: It can store up to eight types of configuration chosen by user.

Measures 2, 3 and 4-wire RTDs.

Transmitter Power Supply: 12 Vcc / 22 mA. 15V (open) / 30 mA (short circuit) – nominal.  
50 Vdc In/Out isolation.

Five-minute warm-up time.

Operating temperature range: 0 to 50 °C.

Relative humidity: 90% RH non-condensing.

Rechargeable batteries, up to 8 hours of operation, depending on the functions used.

RS-232/485 Serial Communication.

Includes instruction manual, carrying case, test leads and battery charger.

Optional Certificate of Calibration.

Dimensions: 137 mm x 225 mm x 70 mm (height, width and depth).

Weight: 2.0 kg approx.

Enclosure Protection Degree: IP20.

1 year warranty, except for rechargeable battery.

#### Notes:

Changes can be introduced in the instrument, altering specifications in this manual.

## 2 - Operation

### 2.1. Parts Identification

#### Front panel

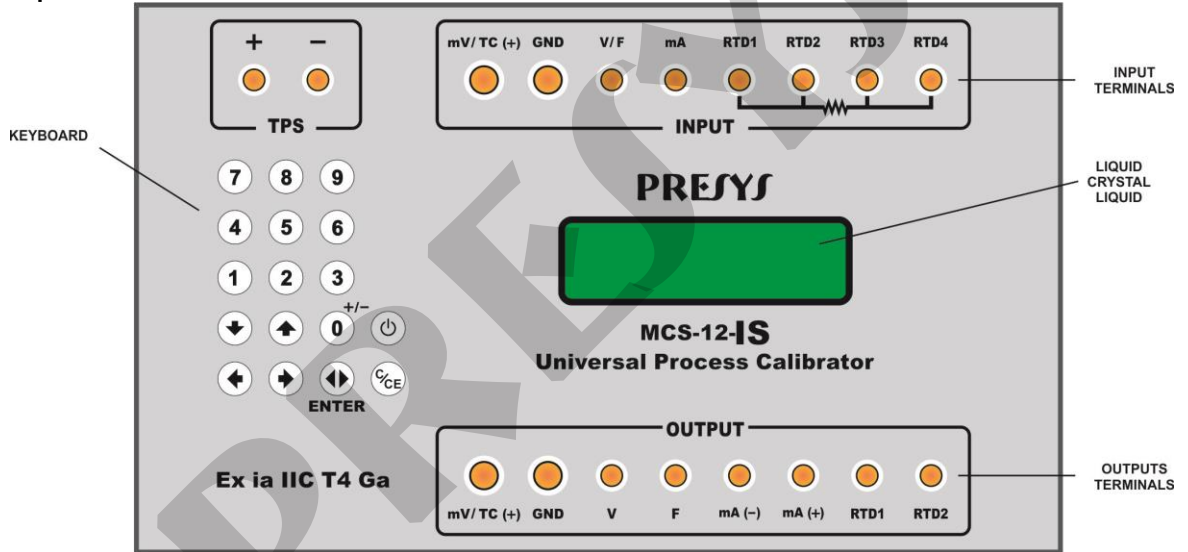

Fig. 01 - Front Panel



Left side-view panel

Right side-view panel

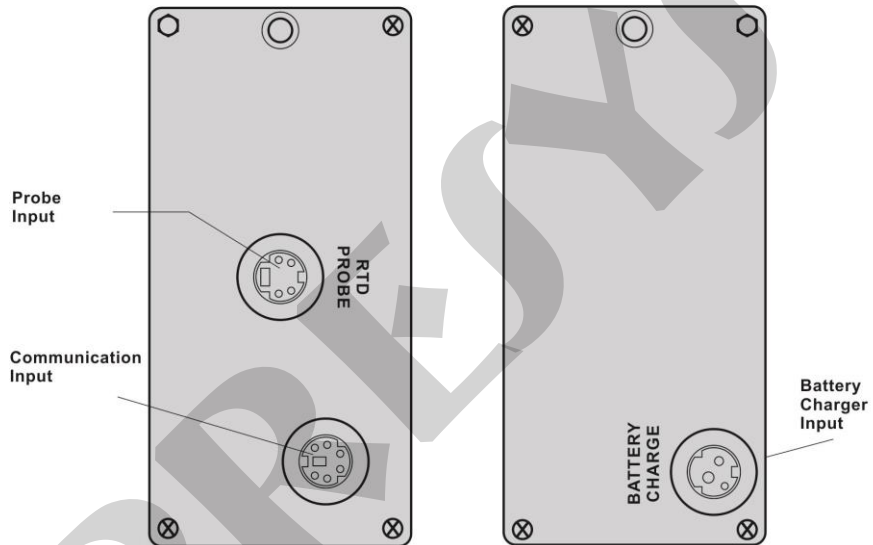

Fig. 02 - Side Panels

## Ways to use the transport bag



**Fig. 03** - Ways to use the transport bag

**Accessories:** The bag has two compartments; one is used to house the calibrator and the other is used to keep several accessories such as probes, adaptor to connect thermocouple wires, spare fuse, straps for transport and use in the field, and also the technical manual.

## 2.2. Battery and charger

The calibrator is supplied with rechargeable batteries which enable up to 8 hours of continuous use. This autonomy is reduced when the current output or the 12 Vdc power supply for transmitters. A charger is also provided, which can be connected to 110 or 220 Vac. Care should be taken when changing the 110-220 Vac selection switch in the charger; time required for a full charge is 14 hours. When the display indicates **LOW BAT**, it is necessary to recharge the instrument, which will continue in operation for a few minutes. **The battery should only be charged in a safe area. Only the charger (CG12-IS) and battery (BT12-IS) specified by Presys must be used, otherwise there is a risk of fire or explosion.**

The batteries used by the calibrator are made of Nickel - Metal Hydride (Ni - MH). This new technology for rechargeable batteries does not have the undesirable characteristics of memory effect and environmental pollution as their preceding batteries made of Nickel Cadmium (Ni-Cd).

## 2.3. Using Calibrator: Basic Functions

When powered on, the calibrator goes through a self-test routine and shows the last adjustment date and the value of the battery voltage. In case of failure, it displays a message to indicate RAM error or E2PROM error; if that occurs, the instrument should be sent for repair. The battery voltage is constantly monitored and the low battery warning is provided.

After the self-test is completed, the display shows the starting menu:

⇒ IN	OUT	EXEC
CONF	ADJ	COM

**IN / OUT** - Selects the input/output functions

**ADJ** - Selects functions which adjust the calibrator itself (see chapter Adjustment).

Do not enter in **ADJ** option before reading the warning in section 4 - Adjustment.

**COM** - Refers to the communication with the computer, described in an appropriate manual.

**EXEC** - Used to activate an input or output option which has been previously selected.

**CONF** - Takes to the sub-menu:

⇒ CF	PRG	MEM	DATE
FN	BAT	LCD	P

**CF** changes both the input and output temperature units from °C to °F and vice-versa. It also enables to choose the temperature scale between IPTS-68 and ITS-90. It follows the encoding scheme described below:

**°C-90**            ITS-90 temperature scale in Celsius degrees.

**°F-68**            IPTS-68 temperature scale in Fahrenheit degrees.

**DATE** updates the internal date and time of the calibrator. Thus, when it performs a calibration previously programmed by the software ISOPLAN, calibration data is recorded together with their date and time of occurrence. Whenever the calibrator is turned off, these data are not updated any longer. Thus, if you want the date and time to be recorded together with the calibration, one should update these data either by means of the keyboard or automatically via the software ISOPLAN. For such, use the vertical arrow keys  $\uparrow$  and  $\downarrow$  to change the value which is blinking and the horizontal arrow keys  $\leftarrow$  and  $\rightarrow$  to go to another value. The ENTER key confirms the last selection.

**BAT** shows the value of the battery voltage

Battery level	Battery state	Display
7.2 to 9.0 V	normal	_____
< 7.2 V	low	<b>LOW BAT</b>

**LCD** performs the setting of the display contrast by means of arrow keys  $\uparrow$  and  $\downarrow$ . Save the last selection by pressing the ENTER key.

**PRG**, **FN** and **MEM** are calibrator special resources described further on.

## 2.4. Measurement or input functions

Select the type of the signal to be measured by using the menus and use the corresponding terminals:

- a) **IN** Selects the input function and the ENTER key should be pressed.

⇒ V	mV	mA	Ohm	OP
F	TC	RTD	SW	NO

Press ENTER to select volt measurement; press ↓, ↑, ← and → to select another signal.

**IN = x.xxxx V**

Display indicates volt input.

**C/CE**

Goes back to previous menu

The other magnitudes follow the same selection process.

When performing the measurement of **OHM**, you must also select the 2-, 3- or 4-wire options. For **TC** (thermocouple), you must select the thermocouple type and cold junction compensation type: **Internal** or **Manual**. With the **Internal** option, compensation is performed internally; in **Manual**, it is necessary to provide the calibrator with the cold junction temperature value, by entering the digits through the numeric keypad.

For **RTD** (thermo-resistance), you must select the type and connection for the 2-, 3- or 4-wire options.

In option **F**, you may select input as a frequency (**Hz**) or the input as a counting (**COUNTER**). If the input is selected as a counting, you must also configure the time indicated by **TIME** parameter.

If **TIME** is set to zero, the pulses received at the input are counted continuously. When **TIME** is set to any value other than zero, it is during this period of time (window) that the counter will count the received pulses. Counting starts immediately after **ENTER** is pressed to confirm the counting time defined in parameter **TIME**.

The remaining counting time (**TIME**) before completion may be seen by pressing the arrow key **←**.

The switch input (**SW**) measures the continuity of an external circuit connected to the calibrator **RTD1** and **RTD4** inputs. When there is continuity, the input indicates **CLOSED**; otherwise, **OPEN** is indicated.

Its most important application is when it is used together with the calibrator output with the purpose of detecting the setpoint of the alarm trigger of an instrument. In this case, the calibrator output is connected to the instrument input and the instrument relay output is connected to the calibrator contact input. The display takes on the following configuration for current output:

**OPEN = 12.0000mA**  
**OUT = 12.0000mA**

In other words, the calibrator output is copied to its input until the moment when the switch changes position; at that time, the input is frozen and the display will show then:

**LOCK = 12.0000mA**  
**OUT = 16.0000mA**

The value displayed in the display upper line together with **LOCK** is the setpoint of the relay alarm. The input is released only when the arrow key **←** is pressed.

The **OP** option refers to the possible optional modules for calibrator and belongs to both calibrator input (**IN**) and output (**OUT**). Pressing ENTER after selecting **OP** takes to the sub-menu:



⇒ **Probe**

**Probe** is related to temperature measurement with an optional 4-wire Pt100 probe. When using the **Probe**, temperatures ranging from – 200.00 °C to 850.00 °C can be measured with high accuracy.

When input sensors break: RTD, resistance and probe, the display shows the burn-out warning identified by the symbol illustrated below:

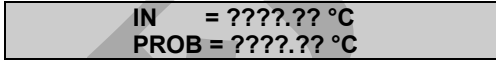

**IN = ????.?? °C**  
**PROB = ????.?? °C**

Whenever the input signal (**IN**) is under or over the input ranges established in item 2.2 on Specifications the display will show **UNDER** or **OVER**, respectively.

The **NO** option deactivate the input function.



## b) Input or measurement connections

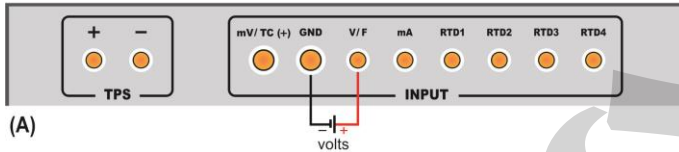

$U_i = 30 \text{ V}$	$U_o = 5.36 \text{ V}$
$I_i = 100 \text{ mA}$	$I_o = 0.546 \text{ mA}$
$P_i = 750 \text{ mW}$	$P_o = 0.802 \text{ mW}$
$C_i = 0 \text{ nF}$	$C_o = 33 \text{ nF}$
$L_i = 400 \text{ } \mu\text{H}$	$L_o = 1.6 \text{ mH}$

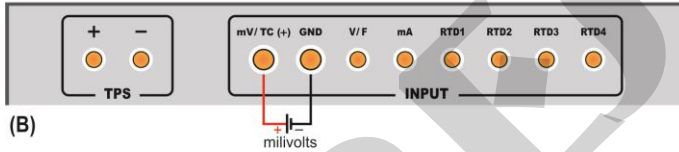

$U_i = 30 \text{ V}$	$U_o = 5.88 \text{ V}$
$I_i = 100 \text{ mA}$	$I_o = 0.495 \text{ mA}$
$P_i = 750 \text{ mW}$	$P_o = 0.728 \text{ mW}$
$C_i = 0 \text{ nF}$	$C_o = 33 \text{ nF}$
$L_i = 400 \text{ } \mu\text{H}$	$L_o = 1.6 \text{ mH}$

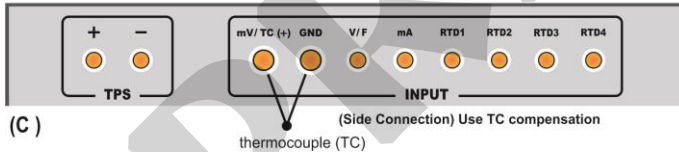

$U_i = 30 \text{ V}$	$U_o = 5.88 \text{ V}$
$I_i = 100 \text{ mA}$	$I_o = 0.495 \text{ mA}$
$P_i = 750 \text{ mW}$	$P_o = 0.728 \text{ mW}$
$C_i = 0 \text{ nF}$	$C_o = 33 \text{ nF}$
$L_i = 400 \text{ } \mu\text{H}$	$L_o = 1.6 \text{ mH}$

Fig. 04 - Input Connections

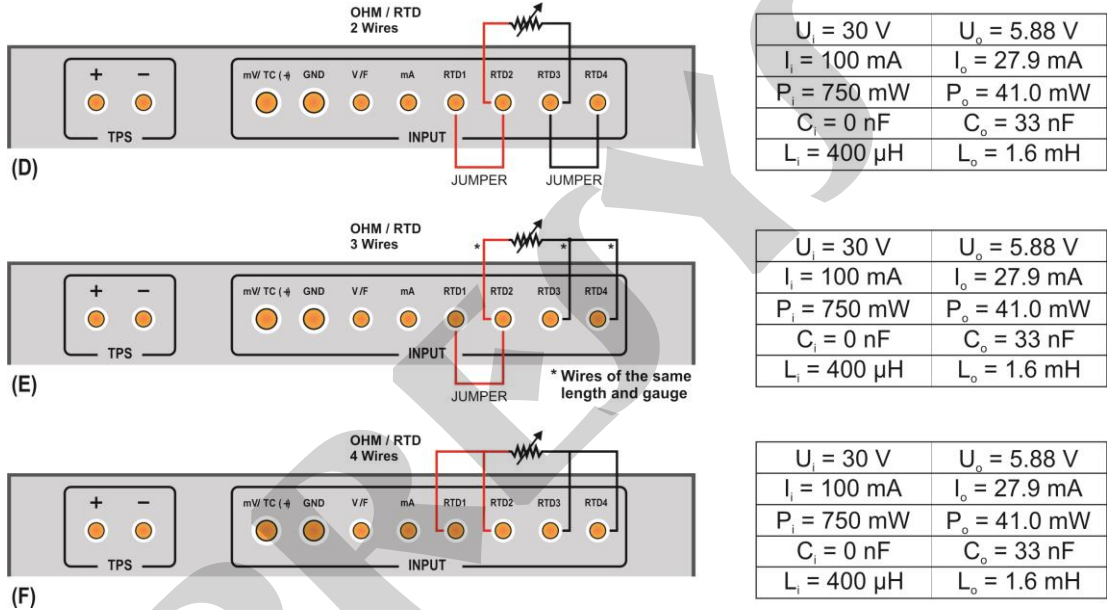
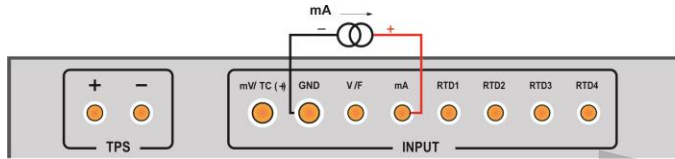
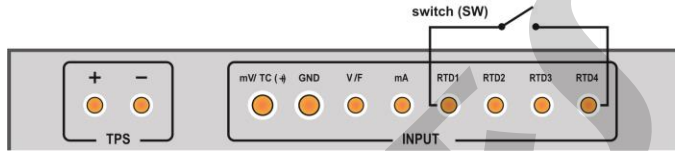

Fig. 04 - (Cont.) Input Connections



(G)

$U_i = 30 \text{ V}$	$U_o = 5.36 \text{ V}$
$I_i = 100 \text{ mA}$	$I_o = 0.297 \text{ mA}$
$P_i = 750 \text{ mW}$	$P_o = 0.437 \text{ mW}$
$C_i = 0 \text{ nF}$	$C_o = 33 \text{ nF}$
$L_i = 400 \text{ } \mu\text{H}$	$L_o = 1.6 \text{ mH}$



(H)

$U_i = 30 \text{ V}$	$U_o = 5.88 \text{ V}$
$I_i = 100 \text{ mA}$	$I_o = 26.9 \text{ mA}$
$P_i = 750 \text{ mW}$	$P_o = 39.5 \text{ mW}$
$C_i = 0 \text{ nF}$	$C_o = 33 \text{ nF}$
$L_i = 400 \text{ } \mu\text{H}$	$L_o = 1.6 \text{ mH}$

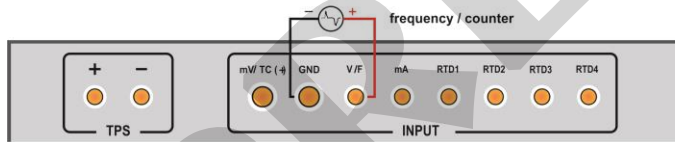

(I)

$U_i = 30 \text{ V}$	$U_o = 5.36 \text{ V}$
$I_i = 100 \text{ mA}$	$I_o = 0.546 \text{ mA}$
$P_i = 750 \text{ mW}$	$P_o = 0.802 \text{ mW}$
$C_i = 0 \text{ nF}$	$C_o = 33 \text{ nF}$
$L_i = 400 \text{ } \mu\text{H}$	$L_o = 1.6 \text{ mH}$

Fig. 04 - (Cont.) Input Connections

## mA input with TPS supply (Ex 2-wire transmitter)

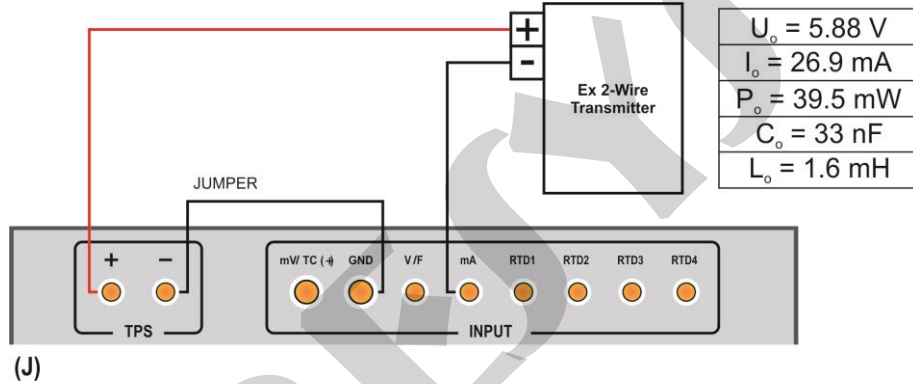
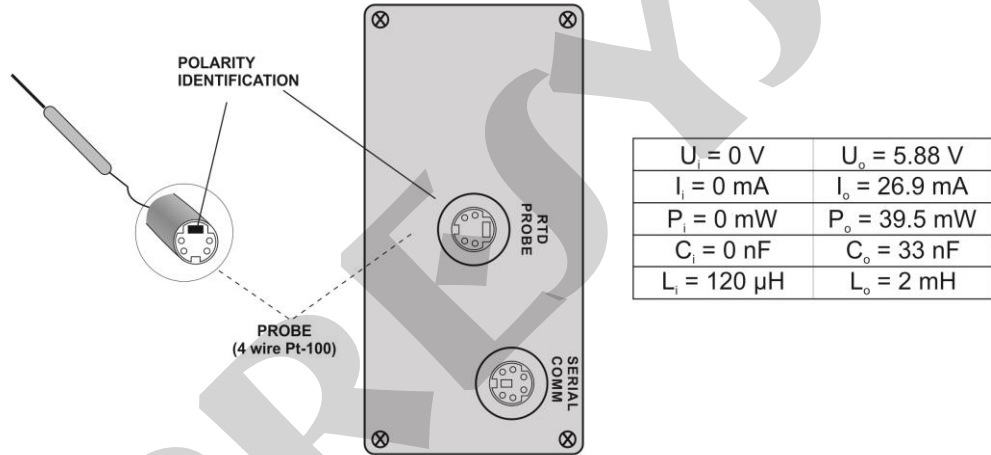

Fig. 04 - (Cont.) Input Connections

### c) Probe Connection (optional)

Connect the Probe to calibrator so that polarity identification (white mark) coincides. Refer to figure below.



**Fig. 05 - Probe Connection**

## 2.5. Generation or Output Functions

Select through the menus the type of signal to be generated and use the corresponding terminals:

a) **OUT**                      Selects the output functions.

⇒ V	mV	mA	Ohm	OP
F	TC	RTD	NO	

Press ENTER to select volt generation, press ↓, ↑, ← and → to select another signal.

**OUT = x.xxxx V** Display indicates the output value in volts. Signal may be inverted by using key 0 (+ / -).

**C/CE**                      Goes back to the previous menu.

For the **RTD** or **OHM** generation, the calibrator simulates electronically a resistance value, that is, there is no resistor but an electronic circuit which behaves as a resistor. It was designed specifically with the purpose of simulating RTD so that the resistor can be connected to instruments such as indicators, transmitters, temperature controllers, with an excitation current within the range of 150  $\mu$ A to 5 mA. For the **OHM** generations, you should choose between the range of 400  $\Omega$  and 2500  $\Omega$ .

For the thermocouple generation, you should choose the type of thermocouple and the type of cold junction compensation.

The **F** option at the output allows you to select frequency generation (10000; 100.00) (**Hz**) or pulse generation (**counter**). In frequency generation, you may set the amplitude (**Level**) of the signal, square wave, which ranges from 0 to 22 V. For the pulse generation, in addition to the amplitude (**Level**) and number of pulses (**#**), you should provide the rate at which pulses must be sent, in Hz. The pulse sequence is sent as soon as ENTER is pressed to confirm the rate at which pulses are emitted. When the arrow key → is pressed at operation level, it is shown the rate at which pulses are emitted.

The **OP** option is the same as it is described for input functions.

The **NO** option deactivates the output function.

## b) Output or generation connections

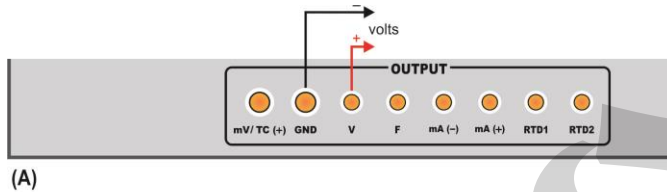

$U_i = 10 \text{ V}$	$U_o = 17.1 \text{ V}$
$I_i = 50 \text{ mA}$	$I_o = 25.1 \text{ mA}$
$P_i = 125 \text{ mW}$	$P_o = 145 \text{ mW}$
$C_i = 100 \text{ nF}$	$C_o = 190 \text{ nF}$
$L_i = 400 \text{ }\mu\text{H}$	$L_o = 1.6 \text{ mH}$

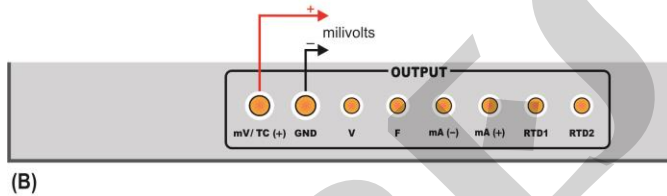

$U_i = 10 \text{ V}$	$U_o = 5.36 \text{ V}$
$I_i = 50 \text{ mA}$	$I_o = 12.2 \text{ mA}$
$P_i = 125 \text{ mW}$	$P_o = 17.9 \text{ mW}$
$C_i = 220 \text{ nF}$	$C_o = 70 \text{ nF}$
$L_i = 400 \text{ }\mu\text{H}$	$L_o = 1.6 \text{ mH}$

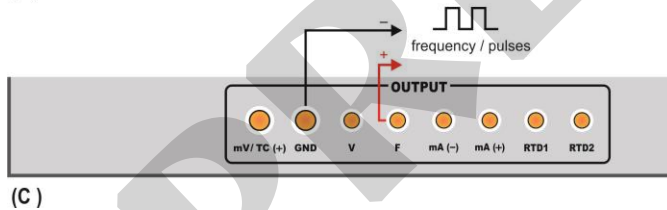

$U_o = 17.1 \text{ V}$
$I_o = 97 \text{ mA}$
$P_o = 560 \text{ mW}$
$C_o = 190 \text{ nF}$
$L_o = 1.0 \text{ mH}$

Fig. 06 - Output Connections

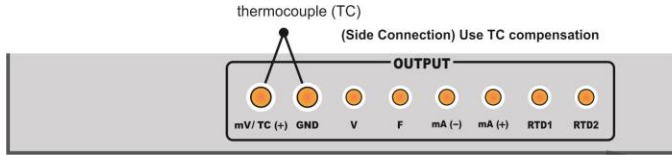

(D)

$U_i = 10 \text{ V}$	$U_o = 5.36 \text{ V}$
$I_i = 50 \text{ mA}$	$I_o = 12.2 \text{ mA}$
$P_i = 125 \text{ mW}$	$P_o = 17.9 \text{ mW}$
$C_i = 220 \text{ nF}$	$C_o = 70 \text{ nF}$
$L_i = 400 \text{ } \mu\text{H}$	$L_o = 1.6 \text{ mH}$

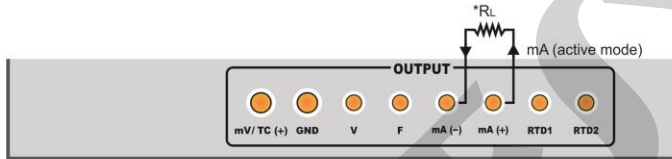

(E)

 $*R_L = \text{Load Resistance}$ 

$U_o = 17.1 \text{ V}$
$I_o = 97 \text{ mA}$
$P_o = 560 \text{ mW}$
$C_o = 190 \text{ nF}$
$L_o = 1.0 \text{ mH}$

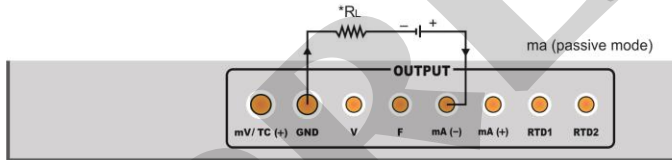

(F)

$U_i = 30 \text{ V}$	$U_o = 5.88 \text{ V}$
$I_i = 100 \text{ mA}$	$I_o = 1.08 \text{ mA}$
$P_i = 750 \text{ mW}$	$P_o = 39.44 \text{ mW}$
$C_i = 0 \text{ nF}$	$C_o = 33 \text{ nF}$
$L_i = 400 \text{ } \mu\text{H}$	$L_o = 1.6 \text{ mH}$

Fig. 06 - (Cont.) Output Connections



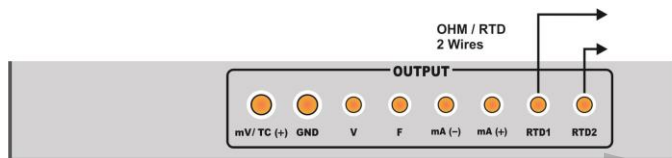

(G)

$U_i = 10 \text{ V}$	$U_o = 11.2 \text{ V}$
$I_i = 50 \text{ mA}$	$I_o = 18.6 \text{ mA}$
$P_i = 125 \text{ mW}$	$P_o = 57.7 \text{ mW}$
$C_i = 26,7 \text{ nF}$	$C_o = 250 \text{ nF}$
$L_i = 400 \text{ }\mu\text{H}$	$L_o = 1.6 \text{ mH}$

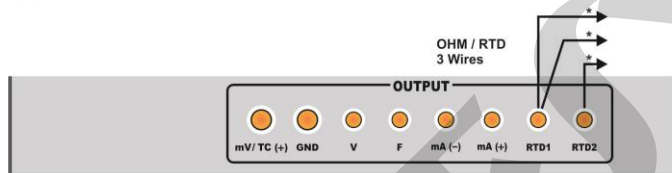

(H)

\* Wires of the same length and gauge

$U_i = 10 \text{ V}$	$U_o = 11.2 \text{ V}$
$I_i = 50 \text{ mA}$	$I_o = 18.6 \text{ mA}$
$P_i = 125 \text{ mW}$	$P_o = 54.7 \text{ mW}$
$C_i = 26,7 \text{ nF}$	$C_o = 250 \text{ nF}$
$L_i = 400 \text{ }\mu\text{H}$	$L_o = 1.6 \text{ mH}$

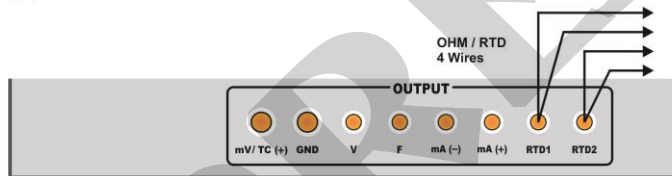

(I)

$U_i = 10 \text{ V}$	$U_o = 11.2 \text{ V}$
$I_i = 50 \text{ mA}$	$I_o = 18.6 \text{ mA}$
$P_i = 125 \text{ mW}$	$P_o = 54.7 \text{ mW}$
$C_i = 100 \text{ nF}$	$C_o = 250 \text{ nF}$
$L_i = 400 \text{ }\mu\text{H}$	$L_o = 1.6 \text{ mH}$

NOTE: There is no polarity for resistance output.

Fig. 06 - (Cont.) Output Connections

## 2.6. Available power supplies

The calibrator has two power supplies galvanically isolated: TPS and +12 Vdc at the output, both provided with short-circuit protection (current limited to 30 mA, open circuit voltage of 15V).

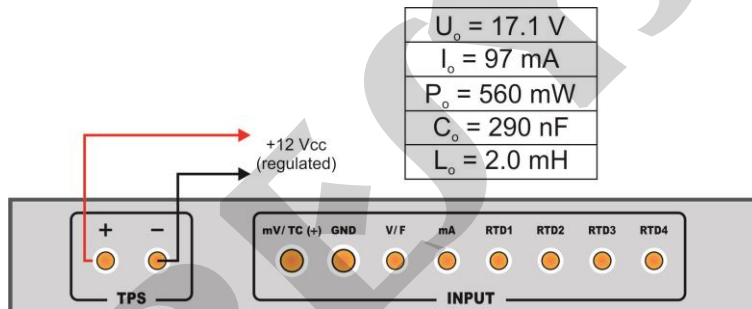

**Fig. 07 - Power Supply**

## 2.7. Calibration examples

### a) Calibration of a temperature transmitter with RTD input and 4-20 mA output.

Through the menus, the calibrator is configured for **mA** input and **RTD** output. TPS, which stands for Transmitter Power Supply, is a 12 Vdc power supply (rated voltage, which may vary depending on the load) which feeds power to transmitter.

In the example, the RTD connection is made by using three wires, and it is simulated by the calibrator. With this kind of connection, there is no measurement error due to the resistance of wires provided that they have the same length and gauge.

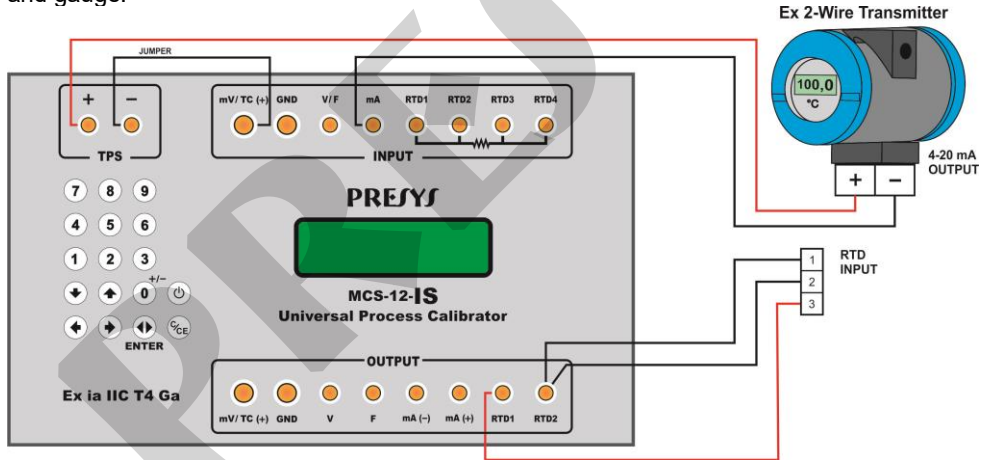
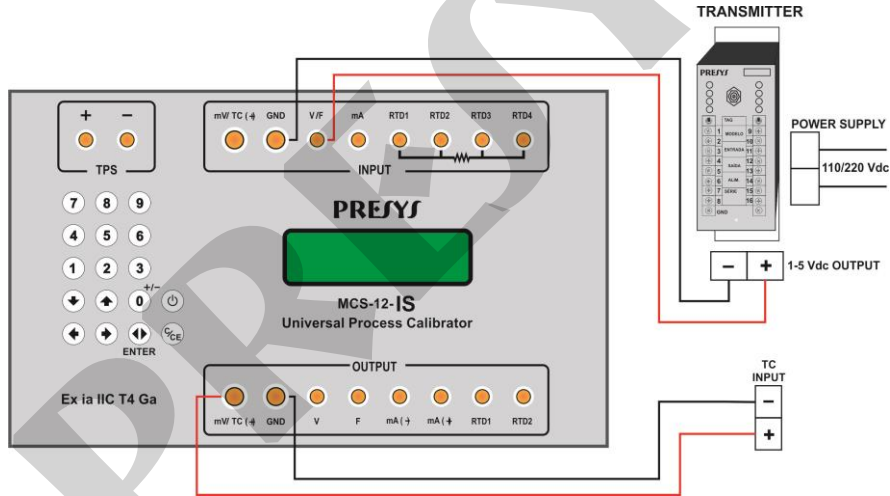

Fig. 08 - Calibration of a temperature transmitter with RTD 3-wire input.

### b) Calibration of a four-wire temperature transmitter with thermocouple input (TC) and 1-5 Vdc output.

Is configured for volt input and TC output (the type of TC should be selected). For the cold junction compensation, you may use the TC compensation wires to set up the connection between the transmitter and the calibrator and program the option for automatic cold junction (**Internal**), or you may measure the temperature of the transmitter terminal set and then enter this value into the calibrator **Manual** option, thus avoiding the use of compensation wires.



**Fig. 09** - Calibration of a four-wire temperature transmitter with thermocouple input (TC) and 1-5 Vdc output.

## 2.8. Special Programming

When **PRG** is selected, the display will show:



This option allows you to select a number of special programming features for **INPUT** or **OUTPUT**. **INPUT** is provided with **FILTER**, **DECIMAL** and **PROBE** options. **OUTPUT** is provided with **STEP** and **RAMP** options.

### 2.8.1. FILTER Programming

The value of this parameter (in seconds) supplies the time constant of a first order digital filter attached to the selected input. When filtering the measured signal is not required, you should simply set this parameter to zero.

Note: For the frequency input the filter has no effect.

### 2.8.2. DECIMAL Programming

The value of this parameter (**0**, **1**, **2**, **3** or **DEFAULT**) indicates the number of decimals with which the value measured at the input will be shown in the display.

Note: **DEFAULT** corresponds to the maximum number of decimals that may display in an input measurement, in compliance with its resolution.

### 2.8.3. Probe

The **PROBE** option is used to configure the parameters using the *Callendar-Van Dusen* curve. Entering this menu, the options will appear.



The **IEC751** option contains the standard table for conversion between resistance and temperature, according to the IEC-60751 standard. When not using a custom correction curve, leave this option selected.

The **CUSTOM** option allows the configuration of CVD parameters. These parameters belong to the equation described below.

$$R(t) = R_0 \cdot \{1 + A \cdot t + B \cdot t^2 + C \cdot t^3 (t-100)\}, C = 0 \text{ for } t \geq 0 \text{ } ^\circ\text{C}.$$

Where  $t$  refers to temperature on this scale and  $R_0$  to resistance at  $0 \text{ } ^\circ\text{C}$ .

Set the value of  $R_0$  and the coefficients  $A$ ,  $B$  and  $C$ , together with their respective exponents in  $E\_A$ ,  $E\_B$  and  $E\_C$ .

## 2.8.4. STEP Programming

The **STEP** programming makes the calibrator output vary in pre-defined steps. It is useful in calibrations where some scale points are verified; for example 0% - 25% - 50% - 75% - 100%.

The output type must be previously configured, otherwise the **Select OUTPUT first** message is shown. In this case, press C/CE to go back to the main menu in order to select the input type.

To activate this programming from the main menu, select **CONF** (ENTER), **PRG** (ENTER) and then **STEP** (ENTER). After this sequence, you will have the options **10%**, **20%**, **25%** and **VARIABLE**; these options define the percentage of variation at the output for each step, the **VARIABLE** option allows you to program the setpoint values of each step, up to a maximum of eleven values.

After the selection of the step variation percentage is completed, the start and the end value of the range within which the output will travel (**High** and **Low setpoint**) are prompted.

By continuing, you go back to the main menu and activate **EXEC**, the output now performs the **STEP** programming, always starting with the beginning of the range, and the arrow keys ↓ or ↑ must be pressed when you want to skip to the following steps.

By pressing the arrow key →, each step will be reached automatically after a preset time is elapsed, which is defined through the keys: 1 (10s), 2 (20s), 3 (30s), 4 (40s), 5 (50s), 6 (60s), 7 (70s), 8 (80s) and 9 (90s). These times are only enabled, once the arrow key → has been pressed, what changes the **STEP** mnemonic to **0s**. Under this situation, the steps are automatically and permanently scanned. If you wish to quit this mode (**STEP** set by time), simply press the arrow key →.

### 2.8.5. RAMP Programming

By using this programming, the calibrator output varies automatically, thus producing ramps and level marks which may be programmed to actuate once or continuously.

The output type must be previously configured, otherwise the **Select OUTPUT first** message is shown. In this case, press C/CE to go back to the main menu in order to select the input type.

From the main menu, select **CONF** (ENTER), **PROG** (ENTER), and **RAMP** (ENTER). Then you must enter the start and the end values of the range within which the output will travel (**High** and **Low setpoint**), and also the value of time (in seconds) required for a complete travel within the range (**Ramp Time**). Another value that may be configured is how long it should dwell at the level mark (**Dwell Time**), that is, the time during which the output remains constant between two ramps.

After the configuration is complete, you have to go back to the main menu and press **EXEC**; the output goes to the starting value of the configured range. When the arrow key **↑** is pressed, an ascending cycle is started, and pressing **↓**, a descending cycle begins, only once. Pressing **↑** and **↓**, cycles are obtained on a continuous basis.



## 2.9. Special Functions

Selecting **FN** the display will show:



With these options, you may select special functions related to the **INPUT** or the **OUTPUT**.

**INPUT** has the **SCALE**, **CAL** and **NO** options.

The input type must be previously configured, otherwise the **Select INPUT first** message is shown. In this case, press C/CE to go back to the main menu in order to select the input type.

## 2.9.1. SCALE Function

It establishes a linear relationship between the calibrator input signal and what is shown at the display, according to the graphic below.

The scaled indication at the display (#) may represent any engineering unit, such as: m/s, m<sup>3</sup>/s, %, etc.

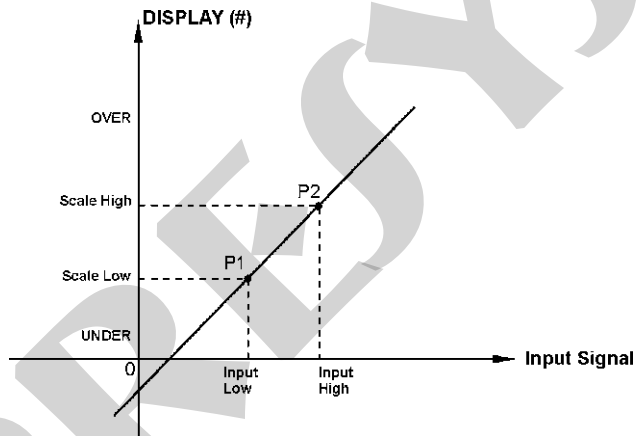

**Fig. 10** - SCALE Function (LINEAR).

The number of decimals, up to 4, shown at the display may be configured by using parameter **Scale Dec**.

The value for **Input High** must be necessarily higher than **Input Low**. On the other hand, **Scale High** and **Scale Low** may have any relationship between themselves: higher than, lower than or equal to, and they may have a signal before them. Thus direct or reverse relationships may be established.

The counter and the contact inputs may not be scaled.

For the current input, a linear relationship may be established as it has been previously shown or it may be squared (**FLOW**) as illustrated below:

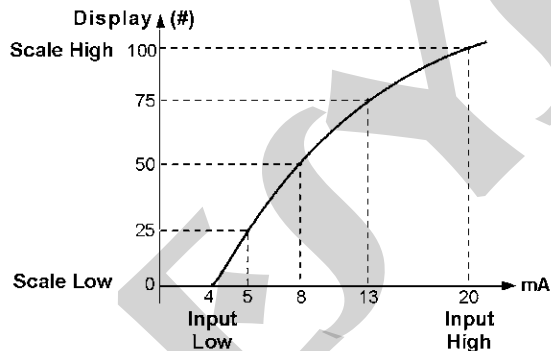

Fig. 11 - SCALE Function (FLOW).

### 2.9.2. CAL Function

The calibrator may be used to calibrate or adjust any transmitter type. In a typical application, it would generate a thermoresistance signal and would measure the output signal in the current input. Due to reasons of quickness and easiness to compare errors at the input and output of the transmitter, the reading of the calibrator current input may be displayed with the same unit of the generated signal, that is, units of temperature. Thus, both readings for the calibrator input and output are scaled in units of temperature and the error can be promptly calculated.

To activate this function, simply fill in the four parameters shown in the graphic below. To access these parameters, press ENTER after **CAL** is indicated in the display.

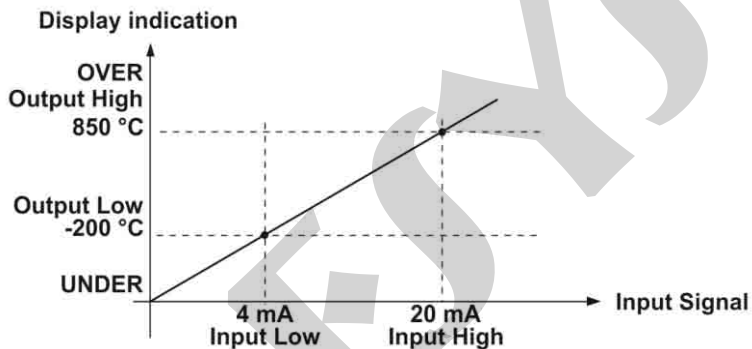

Fig. 12 - CAL Function (LINEAR).

Note that when the **CAL** function is active, the display will indicate **CAL** instead of **IN** as illustrated as follows:

**CAL = 500.23 °C**  
**OUT = 500.00 °C**

To disable the **SCALE** or **CAL** functions, simply select the **NO** option from the menu below and press ENTER.



**OUTPUT** has the **SCALE**, **CONV** and **NO** options described as follows.

The output type must be previously configured, otherwise the **Select OUTPUT first** message is shown. In this case, press C/CE to go back to the main menu in order to select the input type.

### 2.9.3. SCALE Function

The scaling of the calibrator output allows it to simulate the functioning of a transmitter. Transmitter input is made directly by keyboard, and one can get any signal generated by the calibrator as the output signal.

**SCALE** output function relates the output signal generated by the calibrator to the value shown on display, according to the figure below:

The scaled indication at the display (#) may represent any engineering unit, such as: m/s, m<sup>3</sup>/s, %, etc.

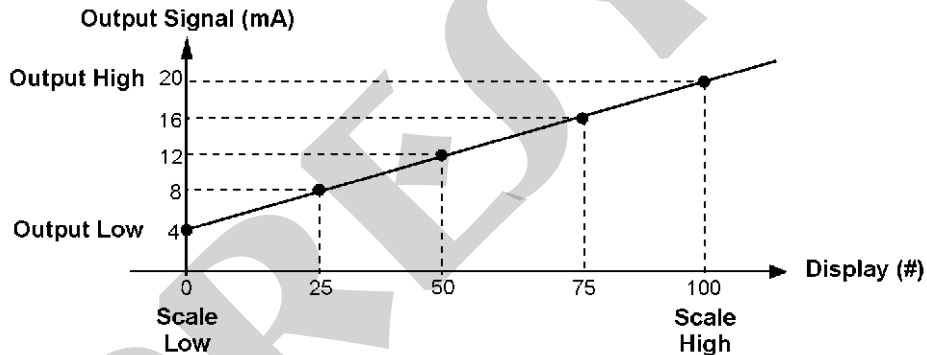

Fig. 13 - SCALE Function (LINEAR).

**Scale Dec** parameter configures the number of decimals presented at the display.

The value of **Output High** must always be higher than **Output Low**. **Scale Low** and **Scale High** parameters may have any relationship between them, provided that they are different. Thus direct or reverse relationships may be established.

Any type of output may be scaled, except for output of pulses.

In case of current output, as well as for the input, a linear or squared (**FLOW**) relationship may be established, as the example provided below.

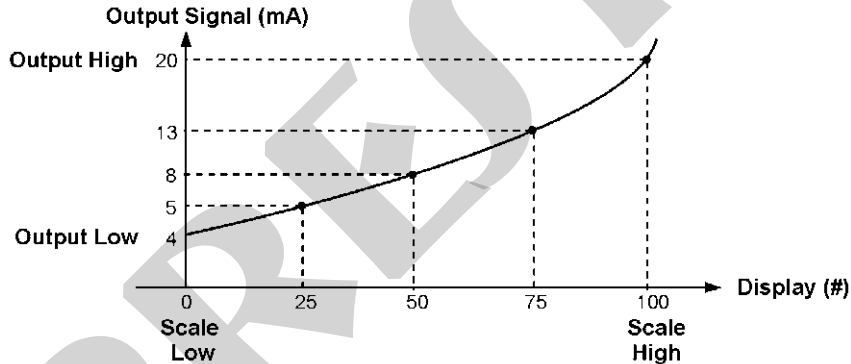

Fig. 14 - SCALE Function (FLOW).

## 2.9.4. CONV Function

By using the **CONV** function, the calibrator may convert any input signal into any output signal with galvanic isolation. It may therefore behave as a real transmitter.

Once the calibrator input and output have been selected, you must fill in the four parameters shown in the graphic below. To access these parameters press ENTER after **CONV** is indicated at the display.

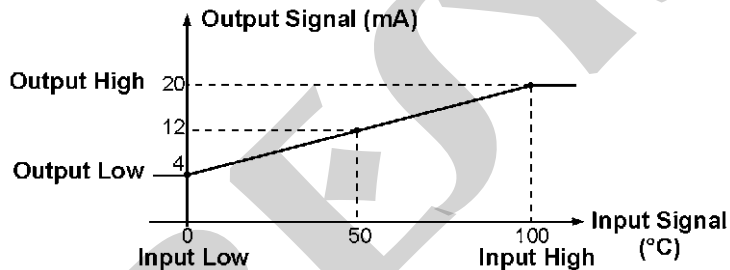

Fig. 15 - CONV Function

The value of **Output High** must always be higher than **Output Low**. **Input High** and **Input Low** parameters must never be equal. Thus any type of direct or reverse retransmission, from input to output, may be obtained.



**SCALE** and **CONV** functions may be disabled by selecting the **NO** option and pressing ENTER, as shown below:



## 2.10. MEM Command

The calibrator accepts a great amount of programmations and special functions that can be often used. In this case, storage of these configurations in the calibrator saves time. One can have up to eight sequences stored in memory.

After making a specific operation in the calibrator through the keyboard, return to the menu that shows **MEM**. Then select **MEM** and press ENTER. The display shows:



Select **WRITE** and press ENTER. The display will show:



The numbers shown above represent eight locations of memory. Select any of them and press ENTER. The current configuration is then stored in the chosen memory location. In order to recall it, even though the calibrator is turned off and on, select **RECALL** (ENTER) and the memory number that stored the previous configuration. Then press ENTER.

Any new configuration can be written over an already used memory location.

When you want to clear all eight memory locations, select **CLEAR ALL** and press ENTER.

## 2.11. Warning Messages

<b>Warning</b>	<b>Meaning</b>	<b>Procedure</b>
<b>RAM ERROR READ MANUAL</b>	Problem in RAM memory	Turn the calibrator off and on. If the error persists, send the instrument to the factory
<b>EEPROM ERROR READ MANUAL</b>	Problem in EEPROM memory	Same as the previous item
<b>LOW RESISTANCE</b>	Short-circuit in mV, TC or V output	Check the impedance at the input circuit connected to the calibrator
<b>CHECK LOOP</b>	mA output is open	Check the continuity of the wiring
<b>LOW BAT</b>	Level of battery voltage is low	Connect the calibrator charger
<b>????.?°C</b>	Input sensor is open	Check input connections and sensor
<b>UNDER / OVER</b>	Input signal out of specifications or scaling range	See item 2.2 on Input Specifications

### 3 - Adjustment

**Warning:** Enter the following options only after understanding them completely. Otherwise, it may be necessary to return the instrument to the factory for readjustment.

Select **ADJ** option from the main menu and press the ENTER key. You should then enter the **PASSWORD** 9875 to access the adjustment menu.

The password functions as a protection to adjustment ranges. After the password is entered the menu displays the options:

⇒ IN	OUT	DATE
------	-----	------

You should then choose whether the adjustment is to be performed over an input range (**IN**) or an output range (**OUT**). **DATE** is an option which allows you to record the date on which the adjustment will be performed and once it has been filled in, it will be displayed every time the instrument is turned on.

Options for **IN** adjustment:

⇒ V	mV	mA
Ohm	CJC	Press

Options for **OUT** adjustment:

⇒ V	mV	mA
Ohm	CJC	Probe

Simply note that the thermocouples will only be adjustment after the **mV** and cold junction (**CJC**) adjustment have been performed. Only in case of **OHM** or **RTD**, you have to perform the **mV** adjustment first.

### 3.1. Input adjustment (IN)

Select the corresponding mnemonic and apply the signals presented in the tables below.

When adjusting inputs, the display shows on the 2<sup>nd</sup> line the value measured by and on the first line the same value is expressed as a percentage.

Note that the applied signals just need to be close to values shown in the table.

Once the signal has been applied, store the values of the 1<sup>st</sup> and 2<sup>nd</sup> calibration points by pressing keys 1 (1<sup>st</sup> point) and 2 (2<sup>nd</sup> point).

<b>mV Input</b>	<b>1<sup>st</sup> point</b>	<b>2<sup>nd</sup> point</b>
G 4	0.000 mV	70.000 mV
G 3	0.000 mV	120.000 mV
G 2	0.000 mV	600.00 mV
G 1	600.00 mV	2400.00 mV

<b>mV Input</b>	<b>1<sup>st</sup> point</b>	<b>2<sup>nd</sup> point</b>
Faixa única	0.0000 V	11.0000 V

<b>mA Input</b>	<b>1<sup>st</sup> point</b>	<b>2<sup>nd</sup> point</b>
Faixa única	0.0000 mA	20.0000 mA

Input adjustment for  $\Omega$  is performed in two steps:

**a) Application of mV signal:**

For the adjustment below, leave terminals RTD3(+) and RTD4(+) short-circuited

<b>mV Signal</b>	<b>Terminals</b>	<b>1<sup>st</sup> point</b>	<b>2<sup>nd</sup> point</b>
V_OHM3	RTD3(+) e GND IN (-)	30.000 mV	40.000 mV
V_OHM4	RTD4(+) e GND IN (-)	30.000 mV	40.000 mV

**b) Application of Standart Resistors:**

Connect a decade-box or standard resistors on terminals RTD1, RTD2, RTD3 and RTD4 (4-wire connection).

<b>resistors</b>	<b>1<sup>st</sup> point</b>	<b>2<sup>nd</sup> point</b>
OHM3	20.000 $\Omega$	50.000 $\Omega$
OHM2	100.000 $\Omega$	500.000 $\Omega$
OHM1	500.000 $\Omega$	2000.000 $\Omega$

**CJC Adjustment**

Measure the temperature of input terminal GND IN and store only the 1<sup>st</sup> point.

<b>Cold Junction</b>	<b>1<sup>st</sup> point</b>
CJC	32.03 °C

## 3.2. Output adjustment (OUT)

The output adjustment (except for CJC and Probe) is performed in STEPS. For each STEP the calibrator outputs a signal of the same type selected which must be measured and stored.

It is also possible to make a simple verification in the last two STEPS of each selected range, further details will be given below.

### 1) V, mV e mA.

For these output ranges, the display shows three information fields.

<b>STEP 1 (1)</b>	<b>88.7% (2)</b>
<b>11.82813 (3)</b>	

Field (1) is the current step. To go to the next step, press  $\uparrow$  and to go backwards, press  $\downarrow$ . In each step, the calibrator outputs the signal automatically.

Field (2) is the intimal value measured by the calibrator, expressed in percentage (%) of the range. Before storing the adjustment values, one should wait a few seconds for output signal stabilization.

Field (3) is the value entered by the user. After output signal measurement, press "ENTER" followed by the value measured and "ENTER" again.

The adjustment of these ranges comprises 5 steps. In steps STEP1 to STEP3, the signals are output and should be measured and stored, by pressing "ENTER". In steps STEP4 and STEP5, signals are output only for verification purpose and no values are stored. The verification points are listed in the table below.

	<b>STEP 4</b>	<b>STEP 5</b>
<b>V</b>	0.00000 V	11.00000 V
<b>mV</b>	0.000 mV	110.000 mV
<b>mA</b>	0.00000 mA	11.0000 mA

## 2) OHM

Due to accuracy reasons, the resistance output must be adjusted using 4-wire resistance reading method see figure 5 (H). Initially, the polarity of the wires is not important as the excitation current can flow in one or the other direction - from RTD1 to RTD2 terminal or from RTD2 to RTD1 terminal.

The adjustment should be performed for both ranges: 400  $\Omega$  and 2500  $\Omega$ .

### STEP 1

This field shows the step of this range adjustment.

It consists of 10 steps. In steps STEP1 to STEP4, the signals are output and should be measured and stored, by pressing "ENTER". At transition from STEP3 to STEP4, the display shows "CHANGE CURRENT DIRECTION". At this time, exchange the banana plugs connected to RTD1 terminal with the ones connected to RTD2 terminal and press "ENTER". After that the adjustment continues up to STEP4. Steps 5 and 6 output signals only for verification purpose and no values are stored.

	<b>STEP 9</b>	<b>STEP 10</b>
<b>400 <math>\Omega</math></b>	0.00 $\Omega$	400.00 $\Omega$
<b>2500 <math>\Omega</math></b>	0.0 $\Omega$	2500.0 $\Omega$

## Probe adjustment

First identify the connector pins for **Probe** input according to the figure below.

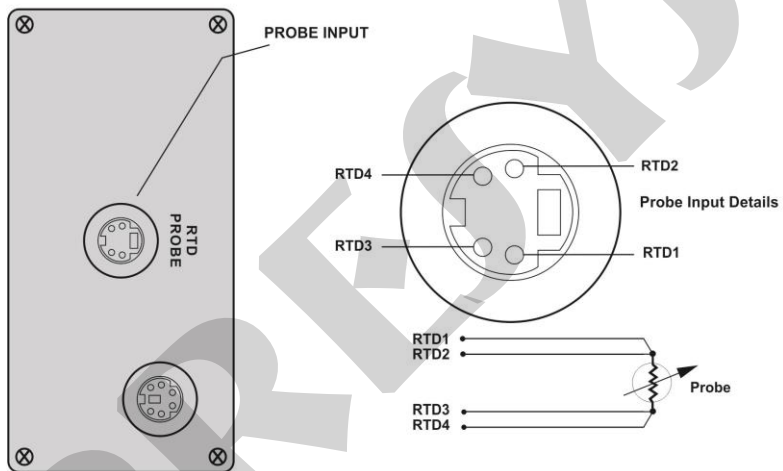

**Fig. 16** - PROBE input connector



The **PROBE** adjustment is performed in two steps:

55

**a) Application of mV signal:**

mV Signal	Terminals	Bornes	1 <sup>st</sup> point	2 <sup>nd</sup> point
V_2	RTD2(+)*	GND OUT (-)	100.000mV	120.000 mV
V_1	RTD2(+)*	GND OUT (-)	120.000mV	600.00 mV

(\*) RTD2, for **PROBE** adjustment, refers to the drawing shown above.

**b) Application of standard resistors:**

Connect a decade box or standard resistor to the probe connector, at positions RTD1, RTD2, RTD3 and RTD4, as shown above.

resistors	1 <sup>st</sup> point	2 <sup>nd</sup> point
R_2	20.000 $\Omega$	50.000 $\Omega$
R_1	100.000 $\Omega$	500.000 $\Omega$

**CJC adjustment**

The adjustment of the cold junction related to the thermocouple output is similar to the one related to the thermocouple input. But the temperature should take at the GND OUT terminal.

## Notes

- Adjusting procedures for this calibrator must be performed under the reference conditions of temperature and humidity.
- Better calibration results are achieved if warm-up time is at least two hours and if the battery charger remains disconnected from the calibrator since one hour before its usage.
- The standards used to adjust this calibrator should have accuracy at least 3 times better than the accuracy values provided in this manual.

DRAFT

**PRESYS** | Instruments Inc.  
[www.presys.com.br](http://www.presys.com.br)

